

/// Orthopädische Instrumente
Orthopaedic Instruments

REBSTOCK®
Precision made in Germany

ORTHOPAEDICS
TRAUMATOLOGY
OSTEOSYNTHESIS

/// 09



Bohrer
Drill Bits



Ø	AO Schaft <i>AO shaft</i>	Länge in mm <i>Length in mm</i>	Runder Schaft <i>Round shaft</i>	Länge in mm <i>Length in mm</i>
1,1 mm	50-90-001	60/35	50-90-012	45/30
1,5 mm	50-90-002	85/60	50-90-013	70/55
2,0 mm	50-90-003	100/75	50-90-014	85/70
2,5 mm	50-90-004	110/85	50-90-015	95/80
2,7 mm	50-90-005	100/75	50-90-016	85/70
3,2 mm	50-90-006	145/120	50-90-017	130/115
3,2 mm	50-90-007	195/170	50-90-018	180/165
3,5 mm	50-90-008	100/85	50-90-019	90/80
3,5 mm	50-90-009	195/170	50-90-020	180/165
4,5 mm	50-90-010	145/120	50-90-021	130/115
4,5 mm	50-90-011	195/170	50-90-022	180/165
4,8 mm			50-90-023	180/165

Gewindeschneider
Taps



Für Schrauben Ø mm <i>For screws Ø mm</i>	Dental Schaft <i>Dental Shaft</i>	AO Schaft <i>AO Shaft</i>	T-Handgriff <i>T-Handle</i>
1,5 mm Dental <i>1.5 mm dental</i>	50-90-101		
2,0 mm Dental <i>2.0 mm dental</i>	50-90-102		
2,7 mm		50-90-103	50-90-110
3,5 mm/Gewindegang 1,25 <i>3.5 mm thread pitch 1.25</i>		50-90-104	50-90-111
3,5 mm/Gewindegang 1,75 <i>3.5 mm/thread pitch 1.75</i>		50-90-105	50-90-112
4,0 mm/Gewindegang 1,75 <i>4.0 mm/thread pitch 1.75</i>		50-90-106	50-90-113
4,5 mm kurzes Gewinde <i>4.5 mm short thread</i>		50-90-107	
4,5 mm langes Gewinde <i>4.5 mm long thread</i>		50-90-108	50-90-114
6,5 mm		50-90-109	50-90-115

Dreibackenfutter mit Handgriff
Three-Jaw Chucks with Handle

50-91-001	T-Handgriff, kanüliert 4,1 mm, mit JACOBS Dreibackenfutter 50-91-006 und Schlüssel 50-91-010, komplett	<i>T-Handle, cannulated 4.1 mm, with JACOBS three-jaw chuck 50-91-006 and key 50-91-010, complete</i>
50-91-002	T-Handgriff, kanüliert 4,1 mm, mit universal Dreibackenfutter 50-91-008 und Schlüssel 50-91-011, komplett	<i>T-Handle, cannulated 4.1 mm, with universal three-jaw chuck 50-91-008 and key 50-91-011, complete</i>



50-91-003	T-Handgriff, kanüliert 4,1 mm, mit universal Dreibackenfutter 50-91-007 und Schlüssel 50-91-010, komplett	<i>T-Handle, cannulated 4.1 mm, with universal three-jaw chuck 50-91-007 and key 50-91-010, complete</i>
-----------	---	--



50-91-004	T-Handgriff mit JACOBS Dreibackenfutter 50-91-009 und Schlüssel 50-91-012, komplett	<i>T-Handle with JACOBS three-jaw chuck 50-91-009 and key 50-91-012, complete</i>
-----------	---	---



50-91-005	Bohrhandgriff mit JACOBS Dreibackenfutter 50-91-009 und Schlüssel 50-91-012, komplett	<i>Drill-Handle with JACOBS three-jaw chuck 50-91-009 and key 50-91-012, complete</i>
-----------	---	---

Dreibackenfutter
Three-Jaw Chucks

50-91-006	JACOBS Dreibackenfutter, 6,35 mm	<i>JACOBS Three-jaw chuck, 6.35 mm</i>	
-----------	----------------------------------	--	---

50-91-007	Universal Dreibackenfutter, 6,35 mm (kann mit Hand oder Schlüssel festgezogen werden)	<i>Universal three-jaw chuck, 6.35 mm (To be tightened by hand or with key)</i>	
-----------	--	---	---



50-91-010	Schlüssel für Dreibackenfutter 50-91-006 und 50-91-007	<i>Key for three-jaw chuck 50-91-006 and 50-91-007</i>
-----------	--	--

50-91-008	Universal Dreibackenfutter, 7,0 mm	<i>Universal three-jaw chuck, 7.0 mm</i>	
-----------	------------------------------------	--	---



50-91-011	Schlüssel für Universal Dreibackenfutter 50-91-008	<i>Key for universal three-jaw chuck 50-91-008</i>
-----------	--	--

50-91-009	JACOBS Dreibackenfutter, 4,5 mm	<i>JACOBS Three-jaw chuck, 4.5 mm</i>	
-----------	---------------------------------	---------------------------------------	---



50-91-012	Schlüssel für JACOBS Dreibackenfutter 50-91-009	<i>Key for JACOBS three-jaw-chuck 50-91-009</i>
-----------	---	---



Handgriffe für Bohrer und Gewindeschneider
Handles for Drill Bits and Taps

50-91-013	T-Handgriff mit A0 Schnellkupplung für Ø 4,5 mm und Ø 6,5 mm Gewindeschneider und Kopfraumräser	<i>T-Handle with A0 quick coupling for Ø 4.5 mm and Ø 6.5 mm taps and countersinks</i>
50-91-014	T-Handgriff mit A0 Schnellkupplung für Ø 4,5 mm und Ø 6,5 mm Gewindeschneider und Kopfraumräser, kanüliert	<i>T-Handle with A0 quick coupling for Ø 4.5 mm and Ø 6.5 mm taps and countersinks, cannulated</i>



50-91-015	Handgriff für Gewindeschneider mit Schnellkupplung	<i>Tap handle with quick coupling</i>
-----------	--	---------------------------------------



50-91-016	Handgriff für Gewindeschneider mit Dentalkupplung	<i>Tap handle with dental coupling</i>
-----------	---	--



Kopfraumfräser
Countersinks



50-91-101	Kopfraumfräser für Ø 1,5 mm und Ø 2,0 mm Schrauben, Spitze Ø 1,1 mm	<i>Countersink for Ø 1.5 mm and Ø 2.0 mm screws, tip Ø 1.1 mm</i>
-----------	---	---



50-91-102	Kopfraumfräser für Ø 2,7 mm, Ø 3,5 mm und Ø 4,0 mm Schrauben, Spitze Ø 2,0 mm	<i>Countersink for Ø 2.7 mm, Ø 3.5 mm and Ø 4.0 mm screws, tip Ø 2.0 mm</i>
-----------	---	---



50-91-103	Malleolar Kopfraumfräser, Ø 3,2 mm für Malleolarschrauben	<i>Malleolar countersink, Ø 3.2 mm tip, for malleolar screws</i>
-----------	---	--



50-91-104	Kopfraumfräser für große Schrauben Ø 4,5 mm und Ø 6,5 mm, Spitze Ø 4,5 mm	<i>Countersink for large screws Ø 4.5 mm and Ø 6.5 mm, tip Ø 4.5 mm</i>
-----------	---	---

Tiefenmessgeräte
Depth Gauges



50-91-105	Tiefenmessinstrument für Ø 1,5 mm und Ø 2,0 mm Schrauben	<i>Depth gauge for Ø 1.5 mm and Ø 2.0 mm screws</i>
50-91-106	Tiefenmessinstrument für Ø 2,7 mm - Ø 4,0 mm Schrauben	<i>Depth gauge for Ø 2.7 mm - Ø 4.0 mm screws</i>
50-91-107	Tiefenmessinstrument für Ø 4,5 mm and Ø 6,5 mm Schrauben	<i>Depth gauge for Ø 4.5 and Ø 6.5 mm screws</i>



50-91-108	Scharfer Haken	<i>Sharp hook</i>
-----------	----------------	-------------------



Schraubendreher
Screw Drivers

50-49-103	Schraubendreher für Ø 3,5 mm und Ø 4,0 mm kanülierte Schrauben, 195 mm	<i>Screw driver Ø 3.5 mm and Ø 4.0 mm cannulated screws, 195 mm</i>
-----------	--	---



50-91-201	Schraubendreher für Schrauben mit Sechskantkopf 1,5 mm, 200 mm	<i>Screw driver for screws with hexagonal head 1.5 mm, 200 mm</i>
-----------	--	---



50-91-203	Schraubendreher für Schrauben mit Sechskantkopf 2,5 mm, 200 mm	<i>Screw driver for screws with hexagonal head 2.5 mm, 200 mm</i>
-----------	--	---



50-91-204	Schraubendreher für Schrauben mit Sechskantkopf 3,5 mm, 200 mm	<i>Screw driver for screws with hexagonal head 3.5 mm, 200 mm</i>
-----------	--	---



50-91-205	Schraubendreher für Schrauben mit PHILIPS Kopf, 200 mm	<i>Screw driver for screws with PHILIPS head, 200 mm</i>
-----------	--	--



Schraubendreher
Screw Drivers



50-91-206	Schraubendreher für Schrauben mit Schlitz, 200 mm	<i>Screw driver for screws with single slot head, 200 mm</i>
-----------	---	--



50-91-207	Schraubendreher für Kreuzschlitz-Schrauben, 200 mm	<i>Screw driver for screws with slotted head, 200 mm</i>
-----------	--	--



Schraubendreher WILLIAMS

Screw driver WILLIAMS

50-91-208	für Schrauben mit PHILIPS Kopf, 230 mm		<i>for screws with PHILIPS head, 230 mm</i>	
50-91-209	für Kreuzschlitz-Schrauben, 230 mm		<i>for screws with slotted head, 230 mm</i>	
50-91-210	für Schrauben mit Schlitz, 230 mm		<i>for screws with single slot head, 230 mm</i>	
50-91-211	für Schrauben mit Sechskant, 3,5 mm, 230 mm		<i>for screws with hexagonal head, 3.5 mm, 230 mm</i>	



50-91-219	Schraubendreher-Einsatz mit Schnellkupplung, 3,5 mm für Schrauben mit Sechskantkopf	<i>Screw driver insert with quick coupling, 3.5 mm for screws with hexagonal head</i>
-----------	---	---



50-91-218	Schraubendreher-Einsatz mit Schnellkupplung, 2,5 mm für Schrauben mit Sechskantkopf	<i>Screw driver insert with quick coupling, 2.5 mm for screws with hexagonal head</i>
-----------	---	---

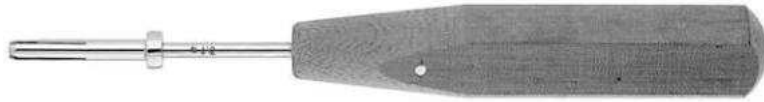

50-91-220	Schraubendreher-Einsatz mit Schnellkupplung, 1,5 mm für Schrauben mit Sechskantkopf	<i>Screw driver insert with quick coupling, 1.5 mm for screws with hexagonal head</i>
-----------	---	---

Schraubendreher
Screw Drivers

50-91-212	Schraubendreher mit Haltehülse für Schrauben, 1,5 mm Sechskant	Screw driver with holding sleeve for screws, 1.5 mm hexagon
-----------	--	---



50-91-213	Haltehülse für Schraubendreher 50-91-212	Holding sleeve for screw driver 50-91-212
-----------	--	---



50-91-216	Schraubendreher mit Haltehülse für Schrauben, 2,5 mm Sechskant	Screw driver with holding sleeve for screws, 2.5 mm hexagon
-----------	--	---



50-91-217	Haltehülse für Schraubendreher 50-91-216	Holding sleeve for screw driver 50-91-216
-----------	--	---



50-91-215	Schraubendreher, 3,5 mm Sechskant	Screw driver, 3.5 mm hexagon
-----------	-----------------------------------	------------------------------



50-91-214	Selbsthaltehülse für Sechskantschraubendreher 50-49-103/50-91-215	Self-holding sleeve for screw driver 50-49-103/50-91-215
-----------	---	--

Schrauben- und Platten-Haltezangen
Screw and Plate Holding Forceps



50-91-100 Schraubenpinzette, selbsthaltend

Screw holding forceps, self-holding



50-91-301 Knochenschrauben-Haltezange

Bone screw holding forceps

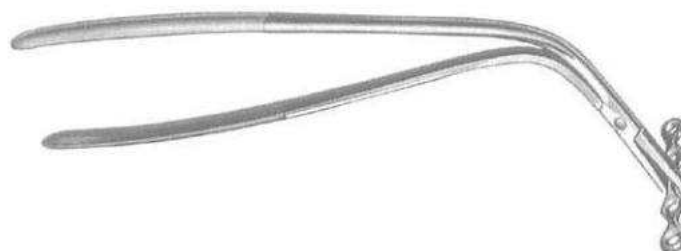

50-91-302 Knochenplatten-Haltezange

Bone plate holding forceps



06-65-107 Zange für Miniplatten, 135 mm

Holding forceps for mini plates, 135 mm



Bohrhülsen und Bohrführungen
Drill Sleeves and Drill Guides

50-91-401	Mini Bohrhülse für Bohrer Ø 1,1 und Ø 1,5 mm	<i>Mini drill sleeve for drill bit Ø 1.1 mm and 1.5 mm</i>
50-91-402	Mini Bohrhülse für Bohrer Ø 1,5 und Ø 2,0 mm	<i>Mini drill sleeve for drill bit Ø 1.5 mm and 2.0 mm</i>



50-91-403	Bohrführung und Bohrhülse für Bohrer Ø 2,0 mm	<i>Drill guide and drill sleeve for drill bit Ø 2.0 mm</i>
-----------	---	--



50-91-404	Gewindeschneiderhülse Ø 3,5 mm/Bohrhülse Ø 2,5 mm für Bohrer und Gewindeschneider für Ø 3,5 mm Kortikalisschrauben mit feinem Gewinde	<i>Tap sleeve Ø 3.5 mm/Drill sleeve Ø 2.5 mm for drill bit and tap for Ø 3.5 mm cortex screws with fine thread</i>
50-91-405	Gewindeschneiderhülse Ø 2,7 mm/Bohrhülse Ø 2,0 mm für Bohrer und Gewindeschneider für Ø 3,5 mm Kortikalisschrauben mit feinem Gewinde	<i>Tap sleeve Ø 2.7 mm/Drill sleeve Ø 2.0 mm for drill bit and tap for Ø 3.5 mm cortex screws with fine thread</i>



50-91-406	Gewindeschneiderhülse, Ø 3,5 mm (auch als Bohrhülse für Ø 3,2 mm)	<i>Tap sleeve, Ø 3.5 mm (also for use as Ø 3.2 mm drill guide)</i>
-----------	---	--



50-91-407	Zielgerät mit Spitze	<i>Pointed drill guide</i>
-----------	----------------------	----------------------------

Bohrhülsen und Bohrführungen
Drill Sleeves and Drill Guides



50-91-408	Gewindeschneiderhülse, Ø 4,5 mm (auch als Bohrhülse für Ø 4,5 mm)	Tap sleeve, Ø 4.5 mm (also for use as Ø 4.5 mm drill guide)
-----------	--	--



50-91-409	Bohrhülse für Rundloch-Platten für Ø 3,2 mm Bohrer, 40 mm	Drill guide for round-hole plates for Ø 3.2 mm drill bit, 40 mm
-----------	--	--



	Bohrhülse neutral	Neutral and load drill guide
50-91-410	2,0 mm für Ø 2,0 mm Schrauben und Ø 1,5 mm Bohrer	2.0 mm for Ø 2.0 mm screws and Ø 1.5 mm drill bit
50-91-411	2,7 mm für Ø 2,7 mm Schrauben und Ø 2,0 mm Bohrer	2.7 mm for Ø 2.7 mm screws and Ø 2.0 mm drill bit
50-91-412	3,5/1,25 mm für Ø 3,5 mm Kortikalisschrauben und Ø 2,5 mm Bohrer	3.5/1.25 mm for Ø 3.5 mm cortex screws and Ø 2.5 mm drill bit
50-91-413	4,5 mm für Ø 4,5 mm Schrauben und Ø 3,2 mm Bohrer	4.5 mm for Ø 4.5 mm screws and Ø 3.2 mm drill bit



	Einsatz-Bohrhülse	Insert drill sleeve
50-91-414	Ø 2,7/2,0 mm für Ø 2,7 mm Kortikalisschrauben und Ø 2,0 mm Bohrer	Ø 2.7/2.0 mm for Ø 2.7 mm cortex screws and Ø 2.0 mm drill bit
50-91-415	Ø 3,5/2,5 mm für Ø 3,5 mm Kortikalisschrauben und Ø 2,5 mm Bohrer	Ø 3.5/2.5 mm for Ø 3.5 mm cortex screws and Ø 2.5 mm drill bit
50-91-416	Ø 4,5/3,2 mm für Ø 3,5 mm Kortikalisschrauben mit feinem Gewinde und Ø 3,2 mm Bohrer	Ø 4.5/3.2 mm for Ø 3.5 mm cortex screws with fine thread and Ø 3.2 mm drill bit



50-91-417	C-Klemmschrauben Bohrhülse mit Gewinde für Ø 4,5 mm Bohrer	C-Clamp drill guide with thread for Ø 4.5 mm drill bit
-----------	---	--

Bohrhülsen und Bohrführungen
Drill Sleeves and Drill Guides

50-91-418	Gewindeschneiderhülse 4,5 mm/Bohrhülse 3,2 mm	Tap sleeve 4.5 mm/Drill sleeve 3.2 mm
-----------	---	---------------------------------------



50-91-419	Bohrhülse für Ø 6,5 mm Schrauben und Ø 3,2 mm Bohrer	Drill guide for Ø 6.5 mm screws and Ø 3.2 mm drill bit
-----------	--	--



50-91-420	Gewindeschneiderhülse 3,5 mm/Bohrhülse 2,5 mm	Tap sleeve 3.5 mm/Drill sleeve 2.5 mm
-----------	---	---------------------------------------



50-91-421	Gewindeschneiderhülse 4,5 mm/Bohrhülse 3,2 mm	Tap sleeve 4.5 mm/Drill sleeve 3.2 mm
-----------	---	---------------------------------------



50-91-422	Bohrhülse 4,5/3,2 mm mit zwei Einsätzen	Drill guide 4.5/3.2 mm with two inserts
-----------	---	---

Biegeinstrumente für Platten
Bending Instruments for Plates



50-91-501	Schränkeisen für Mini- und Finger-Platten	<i>Bending iron for mini and finger plates</i>
-----------	---	--



50-91-503	Schränkeisen für 2,7 mm Platten	<i>Bending iron for 2.7 mm plates</i>
-----------	---------------------------------	---------------------------------------



50-91-502	Schränkeisen für 3,5 mm Platten	<i>Bending iron for 3.5 mm plates</i>
-----------	---------------------------------	---------------------------------------



50-91-504	Biegezange für 1,5 und 2,0 mm Platten	<i>Bending pliers for 1.5 and 2.0 mm plates</i>
-----------	---------------------------------------	---



50-91-505	Biegezange für 2,7 und 3,5 mm Platten, 240 mm	<i>Bending pliers for 2.7 and 3.5 mm plates, 240 mm</i>
-----------	---	---

50-91-506	Biegezange für 1,0 und 1,6 mm Platten, 200 mm	<i>Bending pliers for 1.0 and 1.6 mm plates, 200 mm</i>
-----------	---	---



50-91-507	Biegezange	<i>Bending pliers</i>
-----------	------------	-----------------------



Biegeinstrumente für Platten
Bending Instruments for Plates

50-91-508

 Biege- und Schränkhebel für Standard-Platten
 4 mm und 6 mm

*Bending iron for standard plates
 4 mm and 6 mm*

50-91-509

Biegezange für gerade Platten

Bending pliers for straight plates

50-91-510

 Plattenbiege- und Plattenschränkvorrichtung
 für gerade Platten und Winkelplatten

Bending device to bend straight and angled plates

Plattenspanner
Tension Devices



50-91-601	Bohrlehre für Plattenspanner für Ø 3,2 mm Bohrer	Drill sleeve for tension device for Ø 3.2 mm drill bit
-----------	--	--



50-91-602	Kardanschlüssel, 11 mm	Socket wrench, 11 mm
-----------	------------------------	----------------------



50-91-603	Plattenspanner, 8 mm	Compression device, 8 mm
-----------	----------------------	--------------------------



50-91-604	Ringgabelschlüssel, 11 mm	Combination wrench, 11 mm
-----------	---------------------------	---------------------------



50-91-605	Plattenspanner mit Gelenken, Indikator, Spannweg 20 mm	Articulated tension device with indicator, 20 mm
-----------	--	--



50-91-606	Stiftschlüssel für Plattenspanner	Pin wrench for tension device
-----------	-----------------------------------	-------------------------------



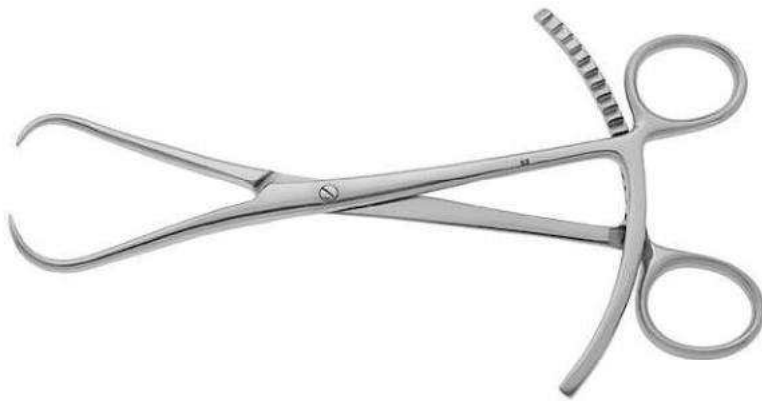

06-15-118 Repositionszange mit Spitzen, 200 mm

Reduction forceps with points, 200 mm

06-15-112 Malleolar Zange, 210 mm

Malleolar forceps, 210 mm

 06-15-106 Zange für Finger mit Drahtführung
 für KIRSCHNER Draht bis Ø 1,0 mm, 170 mm

*Forceps for fingers with drill guide
 for KIRSCHNER wires up to Ø 1.0 mm, 170 mm*

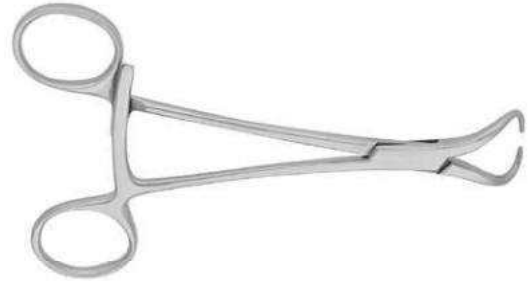
06-15-115

Repositionszange für kleine Fragmente, 135 mm

Reduction forceps for small fragments, 135 mm



06-15-123

Fixationszange mit Sperre, 145 mm

Fixation forceps with ratchet, 145 mm



06-15-116

REIL Repositionszange, 170 mm

REIL Reduction forceps, 170 mm



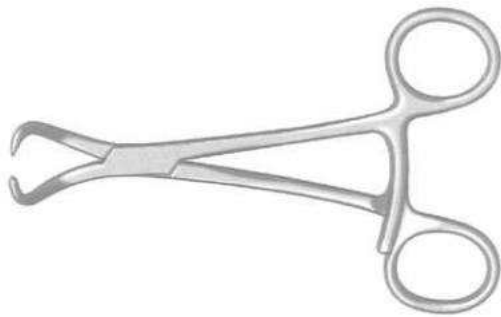

06-65-112 Haltezange mit Kugel

Holding forceps with ball

06-65-119 Repositionszange mit Sperre, gebogen, 130 mm

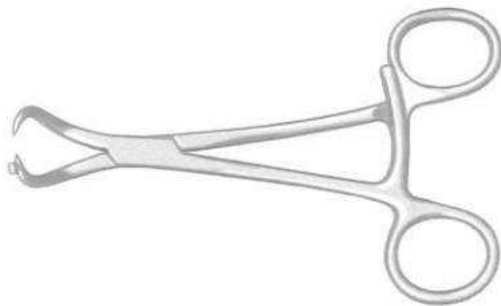
Reduction forceps with ratchet, curved, 130 mm

06-65-115 Repositionszange mit Drahtführung für KIRSCHNER Draht bis Ø 1,6 mm, gebogen, 130 mm

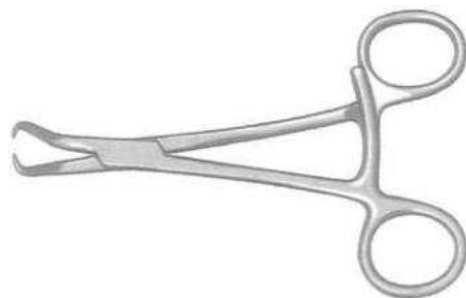
Reduction forceps with wire guide for KIRSCHNER wires up to Ø 1.6 mm, curved, 130 mm

06-65-116 STAGBEETLE Zange mit Spitzen, gebogen, 120 mm

STAGBEETLE Forceps, pointed tips, curved, 120 mm



13-04-455

LEWIN Repositionszange mit Sperre

LEWIN Reduction forceps with ratchet



06-65-113

Repositionszange, 230 mm

Reduction forceps, 230 mm



Repositionszange

Reduction forceps

06-15-124

mit Gewindesperre, 160 mm

with thread lock, 160 mm

06-15-125

mit Gewindesperre, 240 mm

with thread lock, 240 mm



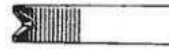

06-15-120 Knochenhaltezeuge, 200 mm

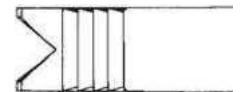
Bone holding forceps, 200 mm

06-15-127 LANGENBECK Knochenhaltezeuge, 210 mm

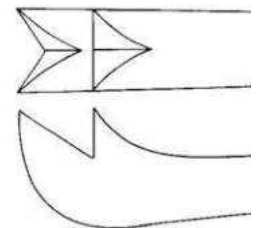
LANGENBECK Bone holding forceps, 210 mm

06-15-130 FERGUSON Knochenhaltezeuge, kräftiges Modell, 210 mm

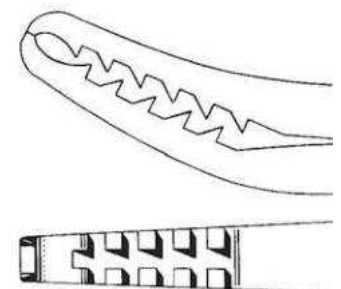
FERGUSON Bone holding forceps, heavy pattern, 210 mm

06-15-136 SEMB Knochenhaltezeuge, 190 mm

SEMB Bone holding forceps, 190 mm

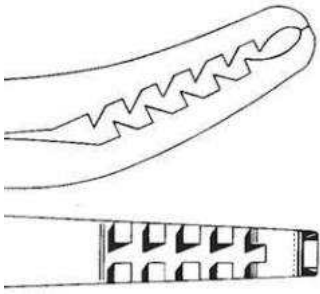

06-15-135 SEMB Knochenhaltezeuge, 190 mm

SEMB Bone holding forceps, 190 mm

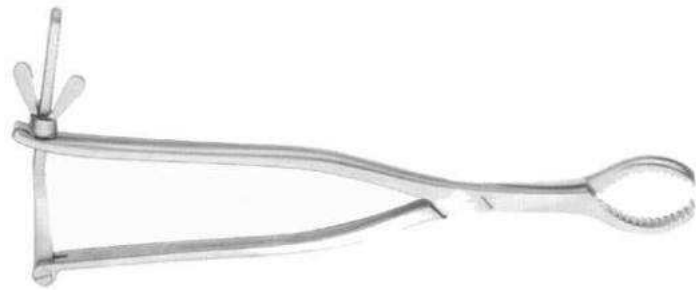

HEY GROVES Knochenhaltezeuge

HEY GROVES Bone holding forceps

06-15-144	210 mm	210 mm
06-15-145	270 mm	270 mm
06-15-146	305 mm	305 mm



Selbstzentrierende Knochenhaltezeuge

Self-centering bone holding forceps

06-15-169	mit Gewindesperre, 150 mm	with thread lock, 150 mm
06-15-170	mit Gewindesperre, 190 mm	with thread lock, 190 mm
06-15-171	mit Gewindesperre, 240 mm	with thread lock, 240 mm
06-15-172	mit Gewindesperre, 260 mm	with thread lock, 260 mm
06-15-173	mit Gewindesperre, 280 mm	with thread lock, 280 mm



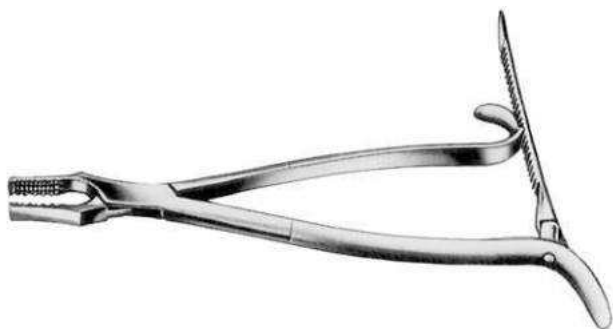

KERN Knochenhaltezange
KERN Bone holding forceps

06-15-148	mit Sperre, 150 mm	with ratchet, 150 mm
06-65-149	ohne Sperre, 150 mm	without ratchet, 150 mm
06-65-155	mit Sperre, 170 mm	with ratchet, 170 mm
06-65-156	ohne Sperre, 170 mm	without ratchet, 170 mm
06-15-158	mit Sperre, 210 mm	with ratchet, 210 mm
06-15-150	ohne Sperre, 210 mm	without ratchet, 210 mm

LANE Knochenhaltezange
LANE Bone holding forceps

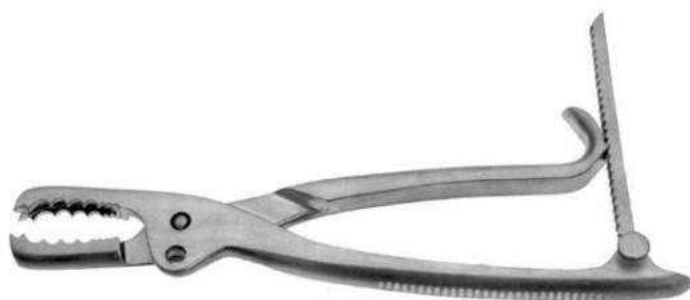
06-15-159	mit Sperre, 320 mm	with ratchet, 320 mm
06-15-151	ohne Sperre, 320 mm	without ratchet, 320 mm
06-65-152	ohne Sperre, 450 mm	without ratchet, 450 mm
06-65-157	mit Sperre, 450 mm	with ratchet, 450 mm

FARABEU-F-LAMBOTTE Knochenhaltezange
FARABEU-F-LAMBOTTE Bone holding forceps

06-15-140	ohne Sperre, 230 mm	without ratchet 230 mm
06-15-143	mit Sperre, 260 mm	with ratchet, 260 mm
06-15-141	ohne Sperre, 260 mm	without ratchet, 260 mm



LAMBOTTE Knochenhalte­zange

LAMBOTTE Bone holding forceps

06-65-153	mit Sperre, 220 mm	with ratchet, 220 mm
06-15-155	mit Sperre, 270 mm	with ratchet, 270 mm
06-65-154	mit Sperre, 300 mm	with ratchet, 300 mm



ULRICH Knochenhalte­zange

ULRICH Bone holding forceps

06-65-133	190 mm	190 mm
06-65-130	230 mm	230 mm
06-65-131	250 mm	250 mm
06-65-132	280 mm	280 mm



06-65-134	ULRICH Knochenhalte­zange, 260 mm	ULRICH Bone holding forceps, 260 mm
-----------	-----------------------------------	-------------------------------------

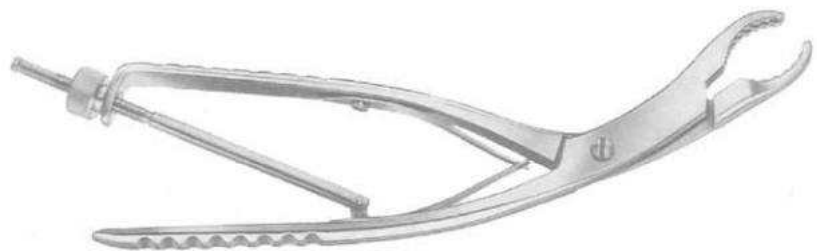

ULRICH Knochenhalte­zange

ULRICH Bone holding forceps

06-65-135	185 mm	185 mm
06-65-136	280 mm	280 mm

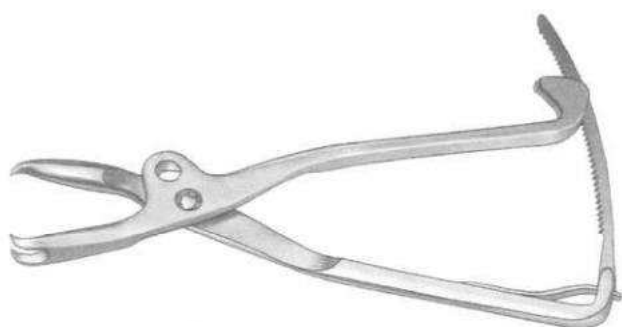

 06-65-151 BISHOP Knochenhaltezeange,
 verstellbare Maulteile mit Sperre, 230 mm

*BISHOP Bone holding forceps
 adjustable jaw with ratchet, 230 mm*

LOWMAN Knochenhalteklammer
LOWMAN Bone holding clamp

06-15-190 1x2 Zähne, 185 mm

1x2 teeth, 185 mm

06-15-191 1x2 Zähne, 200 mm

1x2 teeth, 200 mm

LOWMAN Knochenhalteklammer
LOWMAN Bone holding clamp

06-65-193 1x1 Zähne, 120 mm

1x1 teeth, 120 mm

06-65-194 1x1 Zähne, 185 mm

1x1 teeth, 185 mm

06-65-195 1x1 Zähne, 200 mm

1x1 teeth, 200 mm

VERBRÜGGE Knochenhaltezeange
VERBRÜGGE Bone holding forceps

06-15-180 mit Sperre, 175 mm

with ratchet, 175 mm

06-15-181 mit Sperre, 250 mm

with ratchet, 250 mm

06-15-182 mit Sperre, 260 mm

with ratchet, 260 mm

06-15-183 mit Sperre, 270 mm

with ratchet, 270 mm

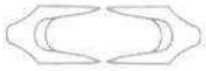

06-15-153 Patella Zange, 2x2 Zähne, 180 mm

Patella forceps, 2x2 teeth, 180 mm

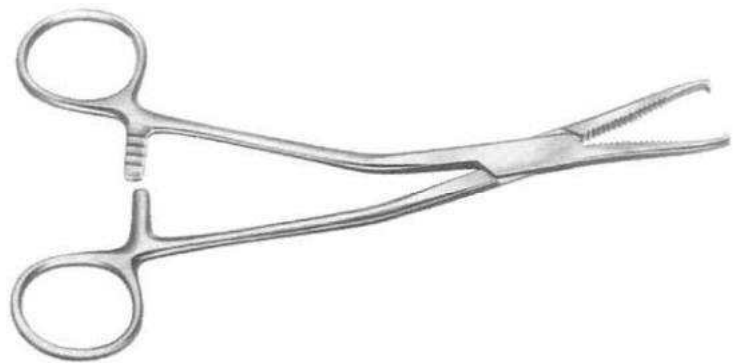

06-15-110 DINGMAN Zange, gewinkelt, 2x2 Zähne, 190 mm

DINGMAN Forceps, angular jaws, 2x2 teeth, 190 mm

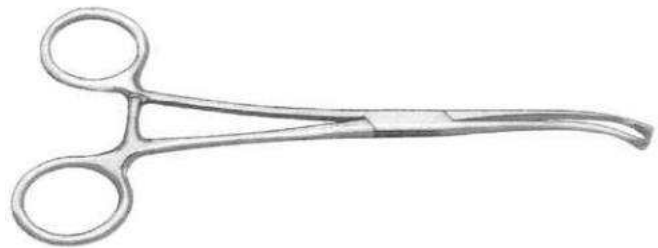

06-65-111 Sesamoidektomie Klemme, 170 mm

Sesamoidectomy clamp, 170 mm

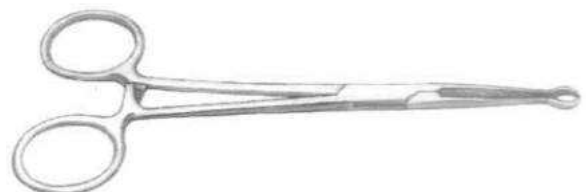

06-65-114 LOCKE Phalangenzange, 1x2 Zähne, 150 mm

LOCKE Phalangeal forceps, 1x2 teeth, 150 mm



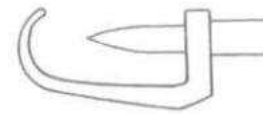
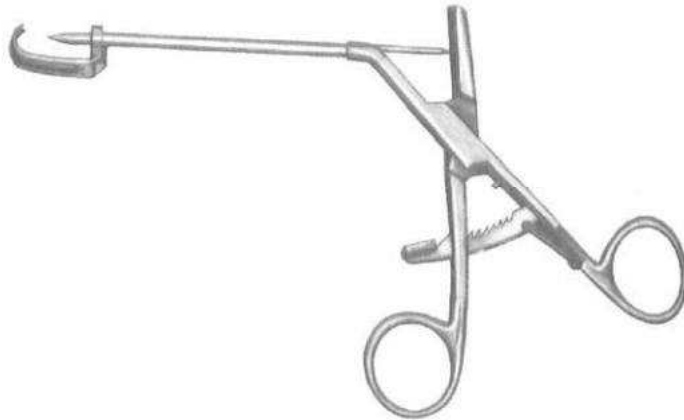

06-65-110 VOGEN Sesamoid Zange

VOGEN Sesamoid clamp

06-65-118 CHARNLEY Knochenhaltezange

CHARNLEY Bone holding forceps

Set beinhaltet:

- 1 Paar hakenförmige Maulteile
- 3 Paar gezahnte Maulteile, 32, 51 und 57 mm

Set includes:

- 1 pair of hooked jaws
- 3 pairs of serrated jaws, 32, 51 and 57 mm





02-20-288 OLLIER Wundhaken, 4 Zähne, stumpf, 230 mm

OLLIER Retractor, 4 prongs, blunt, 230 mm



02-20-285 ISRAEL Wundhaken, 4 Zähne, stumpf, 250 mm

ISRAEL Retractor, 4 prongs, blunt, 250 mm



DEEP RAKE Wundhaken

DEEP RAKE Retractor

02-70-300	57x38 mm, 4 Zähne, stumpf, 270 mm	57x38 mm, 4 prongs, blunt, 270 mm
02-70-301	57x51 mm, 4 Zähne, stumpf, 270 mm	57x51 mm, 4 prongs, blunt, 270 mm
02-70-302	57x64 mm, 4 Zähne, stumpf, 270 mm	57x64 mm, 4 prongs, blunt, 270 mm
02-70-303	57x76 mm, 4 Zähne, stumpf, 270 mm	57x76 mm, 4 prongs, blunt, 270 mm

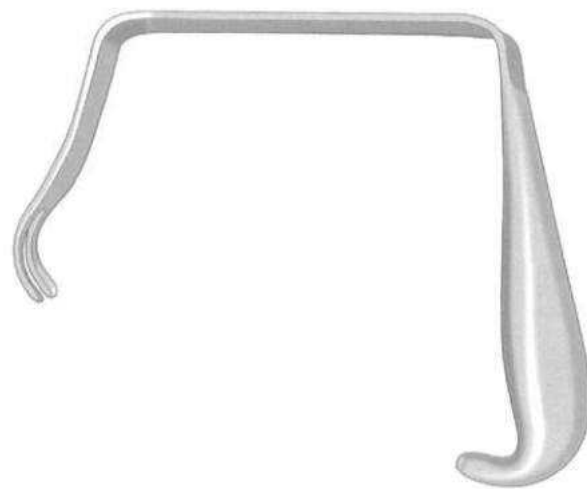

02-70-304 BRISTOW Wundhaken, 2 Zähne, stumpf

BRISTOW Retractor, 2 prongs, blunt



FUKUDA STYLE Wundhaken
FUKUDA STYLE Retractor

06-61-100	mit T-Handgriff, 32x81 mm	with T-Handle, 32x81 mm
06-61-101	mit T-Handgriff, 38x81 mm	with T-Handle, 38x81 mm



06-61-102	Pelvic Wundhaken, stumpf, 24 mm breit, 270 mm	Pelvic retractor, blunt, 24 mm width, 270 mm
-----------	---	--



06-61-103	BRISTOW Wundhaken, stumpf, 190 mm	BRISTOW Retractor, blunt, 190 mm
-----------	-----------------------------------	----------------------------------



06-61-104	Kapsel Wundhaken, scharf, 250 mm	Capsule retractor, sharp, 250 mm
-----------	----------------------------------	----------------------------------





06-11-172 Knochenheber, 22 mm, 220 mm

Bone lever, 22 mm, 220 mm



06-11-176 Knochenheber, 25 mm, 260 mm

Bone lever, 25 mm, 260 mm



06-11-180 BENETT Knochenheber, 65 mm, 235 mm

BENETT Bone lever, 65 mm, 235 mm



06-61-170 LANGE-HOHMANN Knochenheber, 265 mm

LANGE-HOHMANN Bone lever, 265 mm



02-70-419 Knochenheber für Knie, stumpf, 270 mm

Bone lever for knee, blunt, 270 mm



02-20-420 Knochenheber für Knie, stumpf, 175 mm

Bone lever for knee, blunt, 175 mm



06-11-117 HOHMANN Knochenheber, 6 mm, 160 mm

HOHMANN Bone lever, 6 mm, 160 mm





06-11-118 HOHMANN Knochenhebel, 8 mm, 160 mm

HOHMANN Bone lever, 8 mm, 160 mm

06-11-119 HOHMANN Knochenhebel, 15 mm, 125 mm

HOHMANN Bone lever, 15 mm, 125 mm

06-11-185 Knochenhebel, 8 mm, 220 mm

Bone lever, 8 mm, 220 mm

06-11-166 Knochenhebel, 18 mm, spitz, 240 mm

Bone lever, 18 mm, pointed, 240 mm

06-11-171 Knochenhebel, 18 mm, stumpf, 240 mm

Bone lever, 18 mm, blunt, 240 mm

06-11-167 Knochenhebel, 17 mm, 220 mm

Bone lever, 17 mm, 220 mm

06-11-174 Knochenhebel, 43 mm, 240 mm

Bone lever, 43 mm, 240 mm

06-11-175 Knochenhebel, 70 mm, 255 mm

Bone lever, 70 mm, 255 mm

06-11-188 Knochenhebel, 43 mm, 230 mm

Bone lever, 43 mm, 230 mm



06-65-397 KLEINERT-KUTZ Hohlmeißelzange, 140 mm



KLEINERT-KUTZ Bone rongeur, 140 mm

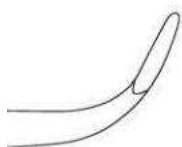

06-65-398 KLEINERT-KUTZ Hohlmeißelzange, 140 mm

KLEINERT-KUTZ Bone rongeur, 140 mm



06-15-409 LUER-FRIEDMANN Hohlmeißelzange, 145 mm



LUER-FRIEDMANN Bone rongeur, 145 mm



06-15-408 Hohlmeißelzange, 145 mm

Bone rongeur, 145 mm

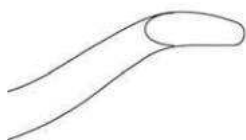

06-15-442 JANSEN Hohlmeißelzange, 190 mm



JANSEN Bone rongeur, 190 mm



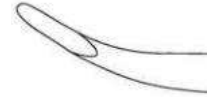

06-15-399 STELLBRINK Hohlmeißelzange, 175 mm

STELLBRINK Bone rongeur, 175 mm

06-15-400 STELLBRINK Hohlmeißelzange, 170 mm

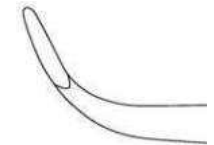
STELLBRINK Bone rongeur, 170 mm

06-15-457 BANE-HARTMANN Hohlmeißelzange, 175 mm

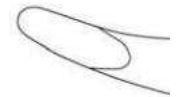
BANE-HARTMANN Bone rongeur, 175 mm

06-15-430 JANSEN Hohlmeißelzange, 175 mm

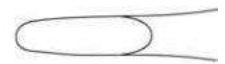
JANSEN Bone rongeur, 175 mm

06-15-432 JANSEN Hohlmeißelzange, 175 mm

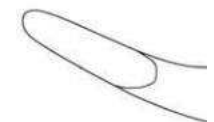
JANSEN Bone rongeur, 175 mm



06-15-410 Hohlmeißelzange, 140 mm

Bone rongeur, 140 mm



06-15-411 LUER Hohlmeißelzange, 150 mm

LUER Bone rongeur, 150 mm

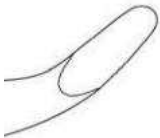

06-15-412 LUER Hohlmeißelzange, 155 mm

LUER Bone rongeur, 155 mm



06-15-415 BLUMENTHAL Hohlmeißelzange, 155 mm

BLUMENTHAL Bone rongeur, 155 mm



06-15-416 BLUMENTHAL Hohlmeißelzange, 155 mm

BLUMENTHAL Bone rongeur, 155 mm

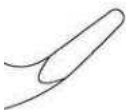

06-15-413 Hohlmeißelzange, 155 mm

Bone rongeur, 155 mm



06-15-414 Hohlmeißelzange, 145 mm

Bone rongeur, 145 mm



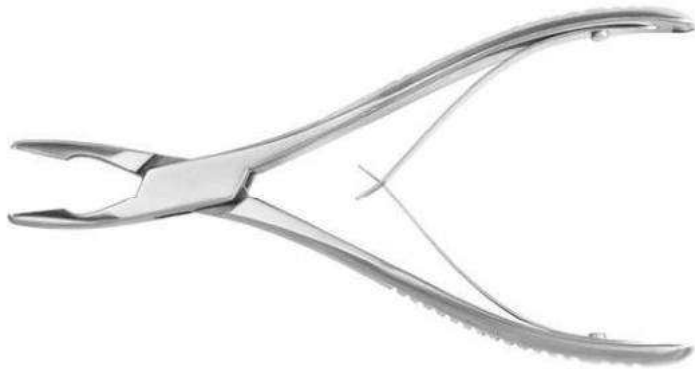

06-15-453 BEYER Hohlmeißelzange, 180 mm

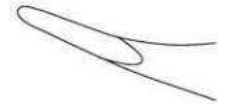
BEYER Bone rongeur, 180 mm

06-65-453 BEYER Hohlmeißelzange, 180 mm

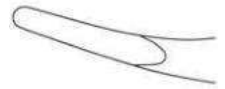
BEYER Bone rongeur, 180 mm

06-15-455 MEAD Hohlmeißelzange, 165 mm

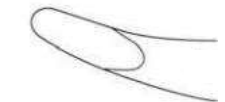
MEAD Bone rongeur, 165 mm

06-15-459 MEAD Hohlmeißelzange, 165 mm

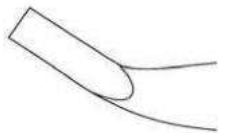
MEAD Bone rongeur, 165 mm

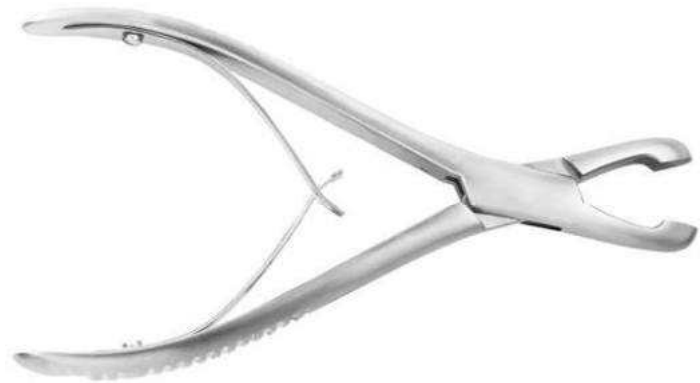

06-15-460 LUER Hohlmeißelzange, gerade, 175 mm

LUER Bone rongeur, straight, 175 mm

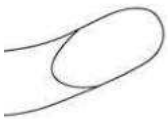

06-15-461 LUER Hohlmeißelzange, gebogen, 175 mm

LUER Bone rongeur, curved, 175 mm



06-15-462 LUER Hohlmeißelzange, gerade, 180 mm

LUER Bone rongeur, straight, 180 mm

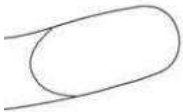

06-15-463 LUER Hohlmeißelzange, gebogen, 180 mm

LUER Bone rongeur, curved, 180 mm

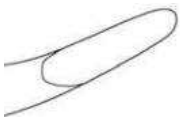

06-15-470 OLIVECRONA Hohlmeißelzange, 205 mm

OLIVECRONA Bone rongeur, 205 mm



06-15-472 GULEKE Hohlmeißelzange, 205 mm

GULEKE Bone rongeur, 205 mm

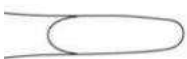

06-15-475 PENNY BACKER Hohlmeißelzange, 205 mm

PENNY BACKER Bone rongeur, 205 mm

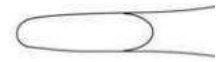
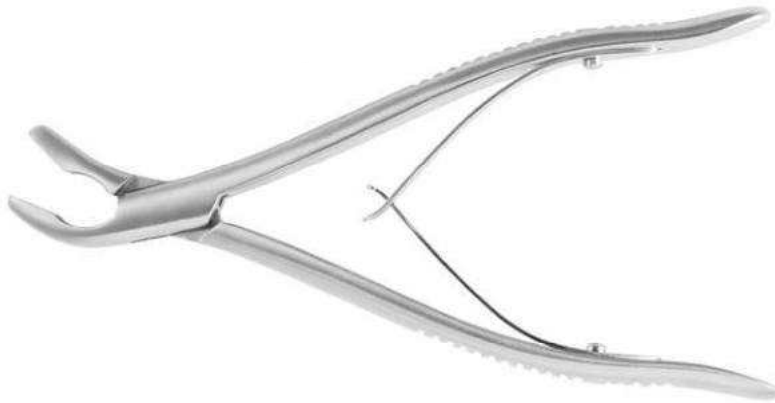

06-15-428	HAKANSSON Hohlmeißelzange, seitwärts gebogen, 170 mm	HAKANSSON Bone rongeur, curved to side, 170 mm
-----------	--	--



06-15-467	TROTTER Hohlmeißelzange, seitwärts gebogen, 205 mm	TROTTER Bone rongeur, curved to side, 205 mm
-----------	--	--



06-65-449	LEMPERT Hohlmeißelzange, gerade, 160 mm	LEMPERT Bone rongeur, straight, 160 mm
-----------	---	--

06-15-450	LEMPERT Hohlmeißelzange, gerade, 200 mm	LEMPERT Bone rongeur, straight, 200 mm
-----------	---	--



06-65-452	LEMPERT Hohlmeißelzange, gebogen, 160 mm	LEMPERT Bone rongeur, curved, 160 mm
-----------	--	--------------------------------------

06-15-451	LEMPERT Hohlmeißelzange, gebogen, 200 mm	LEMPERT Bone rongeur, curved, 200 mm
-----------	--	--------------------------------------





06-15-511

MAYFIELD Hohlmeißelzange, 175 mm

MAYFIELD Bone rongeur, 175 mm



06-15-520

MARQUARDT Hohlmeißelzange, 200 mm

MARQUARDT Bone rongeur, 200 mm



06-65-516

RÖTTGEN-RUSKIN Hohlmeißelzange, 190 mm

RÖTTGEN-RUSKIN Bone rongeur, 190 mm

06-65-517

RÖTTGEN-RUSKIN Hohlmeißelzange, 240 mm

RÖTTGEN-RUSKIN Bone rongeur, 240 mm

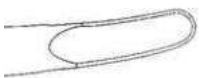

06-15-518

RUSKIN Hohlmeißelzange, 190 mm

RUSKIN Bone rongeur, 190 mm

06-15-521

RUSKIN Hohlmeißelzange, 240 mm

RUSKIN Bone rongeur, 240 mm





06-15-534 STILLE-RUSKIN Hohlmeißelzange, 240 mm

STILLE-RUSKIN Bone rongeur, 240 mm

06-15-514 BEYER Hohlmeißelzange, 180 mm

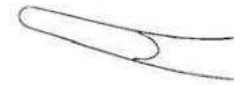
BEYER Bone rongeur, 180 mm

06-15-515 ZAUFAL JANSEN Hohlmeißelzange, 180 mm

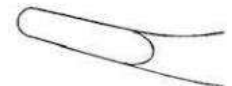
ZAUFAL JANSEN Bone rongeur, 180 mm



06-65-500 BOEHLER Hohlmeißelzange, gerade, 1,7 mm, 150 mm



BOEHLER Bone rongeur, straight, 1.7 mm, 150 mm

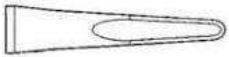

06-65-501 BOEHLER Hohlmeißelzange, gerade, 2 mm, 150 mm

BOEHLER Bone rongeur, straight, 2 mm, 150 mm



06-15-500 BOEHLER Hohlmeißelzange, gebogen, 2 mm, 150 mm

BOEHLER Bone rongeur, curved, 2 mm, 150 mm

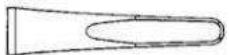

06-65-502 BOEHLER Hohlmeißelzange, gerade, 3 mm, 150 mm

BOEHLER Bone rongeur, straight, 3 mm, 150 mm



06-15-502 BOEHLER Hohlmeißelzange, gebogen, 3 mm, 150 mm

BOEHLER Bone rongeur, curved, 3 mm, 150 mm



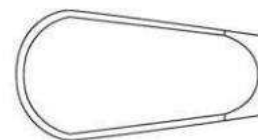

06-65-553	STILLE LUER Hohlmeißelzange, gerade, 230 mm	STILLE LUER Bone rongeur, straight, 230 mm
06-65-554	STILLE LUER Hohlmeißelzange, gerade, 270 mm	STILLE LUER Bone rongeur, straight, 270 mm

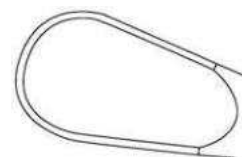

06-65-556	STILLE LUER Hohlmeißelzange, gebogen, 230 mm	STILLE LUER Bone rongeur, curved, 230 mm
06-15-566	STILLE LUER Hohlmeißelzange, gebogen, 270 mm	STILLE LUER Bone rongeur, curved, 270 mm



06-15-550	STILLE LUER Hohlmeißelzange, gerade, 225 mm	STILLE LUER Bone rongeur, straight, 225 mm
06-65-551	STILLE LUER Hohlmeißelzange, gerade, 270 mm	STILLE LUER Bone rongeur, straight, 270 mm

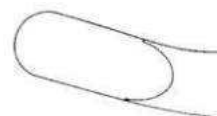

06-15-551	STILLE LUER Hohlmeißelzange, gebogen, 225 mm	STILLE LUER Bone rongeur, curved, 225 mm
06-65-552	STILLE LUER Hohlmeißelzange, gebogen, 270 mm	STILLE LUER Bone rongeur, curved, 270 mm



06-15-530	STILLE LUER Hohlmeißelzange, gerade, 230 mm	STILLE LUER Bone rongeur, straight, 230 mm
-----------	---	--

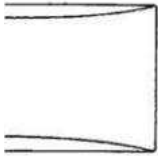

06-15-572 SAUERBRUCH Hohlmeißelzange, 310 mm

SAUERBRUCH Bone rongeur, 310 mm



06-15-570 SAUERBRUCH Hohlmeißelzange, 310 mm

SAUERBRUCH Bone rongeur, 310 mm

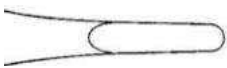

06-65-531 LEKSELL-STILLE Hohlmeißelzange, 4 mm, 240 mm

LEKSELL-STILLE Bone rongeur, 4 mm, 240 mm

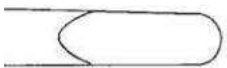

06-15-532 LEKSELL-STILLE Hohlmeißelzange, 8 mm, 240 mm

LEKSELL-STILLE Bone rongeur, 8 mm, 240 mm

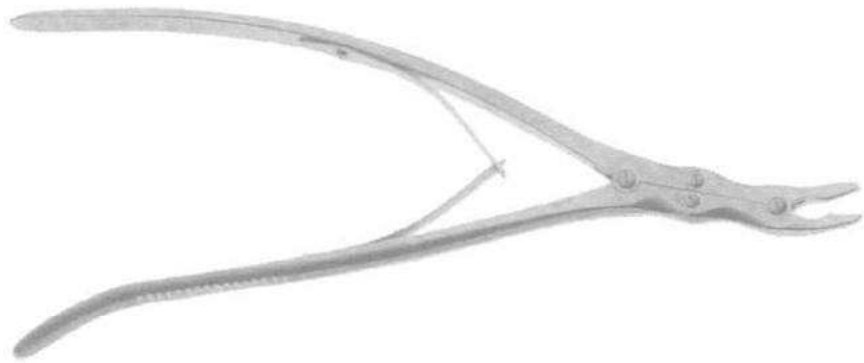

06-65-563 DALE Hohlmeißelzange, gebogen, 3 x 16 mm, 360 mm

DALE Bone rongeur, curved, 3 x 16 mm, 360 mm

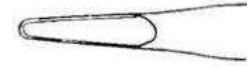

06-65-510 SMITH PETERSEN Hohlmeißelzange
 3 mm, gerade, 240 mm

SMITH PETERSEN Bone rongeur
 3 mm, straight, 240 mm

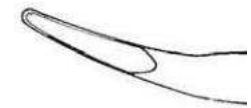
06-65-511 SMITH PETERSEN Hohlmeißelzange
 3 mm, gebogen, 240 mm

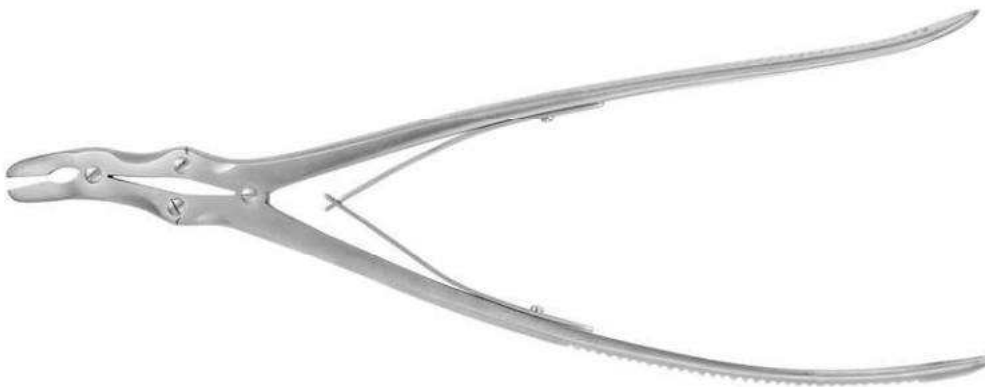
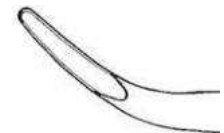
SMITH PETERSEN Bone rongeur
 3 mm, curved, 240 mm

06-65-512 SMITH PETERSEN Hohlmeißelzange
 3 mm, gebogen, 240 mm

SMITH PETERSEN Bone rongeur
 3 mm, curved, 240 mm

06-65-560 LEKSELL Hohlmeißelzange, 360 mm

LEKSELL Bone rongeur, 360 mm

06-65-561 LEKSELL Hohlmeißelzange, 360 mm

LEKSELL Bone rongeur, 360 mm

06-65-562 LEKSELL Hohlmeißelzange, 360 mm

LEKSELL Bone rongeur, 360 mm

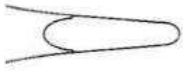
06-15-525 FRYKHOLM Hohlmeißelzange, 240 mm

FRYKHOLM Bone rongeur, 240 mm

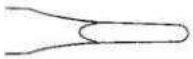

06-15-522 ECHLIN Hohlmeißelzange, 2 mm, 230 mm

ECHLIN Bone rongeur, 2 mm, 230 mm



06-15-523 ECHLIN Hohlmeißelzange, 3 mm, 230 mm

ECHLIN Bone rongeur, 3 mm, 230 mm



06-65-524 ECHLIN Hohlmeißelzange, 4 mm, 230 mm

ECHLIN Bone rongeur, 4 mm, 230 mm

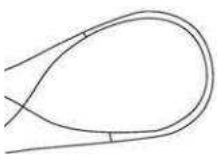

06-15-555 SEMB Hohlmeißelzange, 240 mm

SEMB Bone rongeur, 240 mm

06-65-557 SEMB Hohlmeißelzange, 270 mm

SEMB Bone rongeur, 270 mm



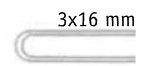
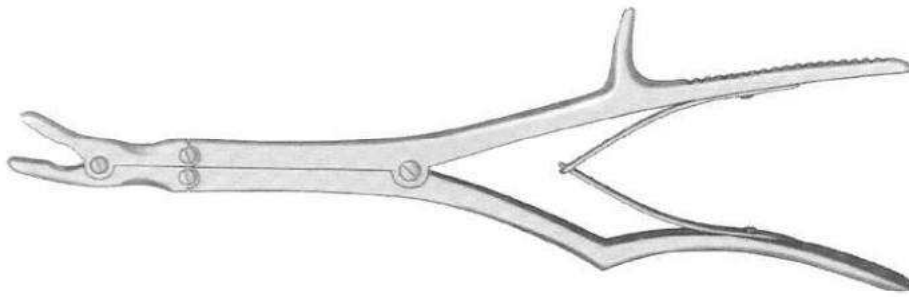

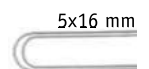
06-57-050 SYPERT Hohlmeißelzange, 3x16 mm, 360 mm

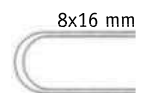
SYPERT Bone rongeur, 3x16 mm, 360 mm

06-57-051 SYPERT Hohlmeißelzange, 5x16 mm, 360 mm

SYPERT Bone rongeur, 5x16 mm, 360 mm

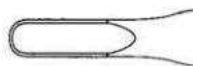
06-07-052 SYPERT Hohlmeißelzange, 8x16 mm, 360 mm

SYPERT Bone rongeur, 8x16 mm, 360 mm

06-65-535 LEKSELL Hohlmeißelzange, 3 mm, 230 mm

LEKSELL Bone rongeur, 3 mm, 230 mm

06-65-536 LEKSELL Hohlmeißelzange, 5 mm, 230 mm

LEKSELL Bone rongeur, 5 mm, 230 mm

06-65-537 LEKSELL Hohlmeißelzange, 8 mm, 230 mm

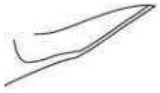
LEKSELL Bone rongeur, 8 mm, 230 mm



06-15-601 Knochensplitterzange, 150 mm

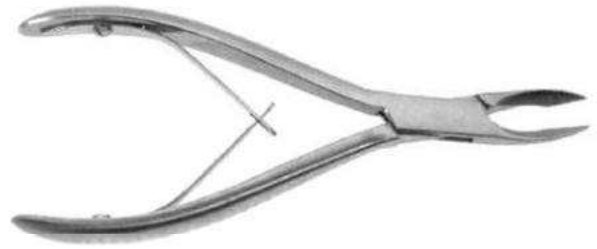

Bone cutting forceps, 150 mm



06-15-602 Knochensplitterzange, 170 mm

Bone cutting forceps, 170 mm

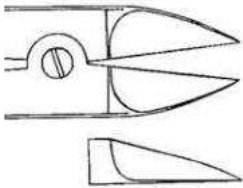

06-15-610 BOEHLER Knochensplitterzange, 145 mm



BOEHLER Bone cutting forceps, 145 mm

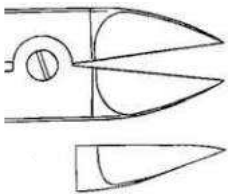

06-15-611 BOEHLER Knochensplitterzange, 145 mm

BOEHLER Bone cutting forceps, 145 mm

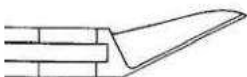

06-15-614 MCINDOE Knochensplitterzange, 175 mm



MCINDOE Bone cutting forceps, 175 mm





06-15-620 LISTON Knochensplitterzange, gerade, 140 mm

LISTON Bone cutting forceps, straight, 140 mm

06-15-622 LISTON Knochensplitterzange, gerade, 170 mm

LISTON Bone cutting forceps, straight, 170 mm

06-15-624 LISTON Knochensplitterzange, gerade, 200 mm

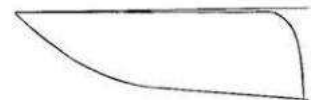
LISTON Bone cutting forceps, straight, 200 mm

06-15-626 LISTON Knochensplitterzange, gerade, 220 mm

LISTON Bone cutting forceps, straight, 220 mm

06-65-631 LISTON Knochensplitterzange, gebogen, 140 mm

LISTON Bone cutting forceps, curved, 140 mm

06-15-632 LISTON Knochensplitterzange, gebogen, 170 mm

LISTON Bone cutting forceps, curved, 170 mm

06-15-634 LISTON Knochensplitterzange, gebogen, 200 mm

LISTON Bone cutting forceps, curved, 200 mm

06-15-636 LISTON Knochensplitterzange, gebogen, 220 mm

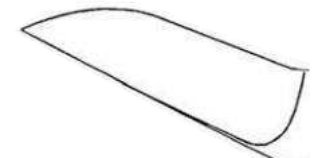
LISTON Bone cutting forceps, curved, 220 mm

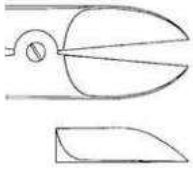

06-15-640 RUSKIN LISTON Knochensplitterzange, gerade, 190 mm

RUSKIN LISTON Bone cutting forceps, straight, 190 mm

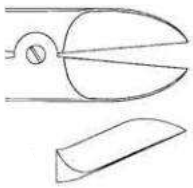

06-15-641 RUSKIN LISTON Knochensplitterzange, gebogen, 190 mm

RUSKIN LISTON Bone cutting forceps, curved, 190 mm

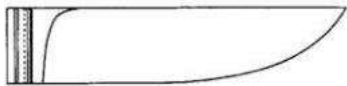

06-15-646 STILLE LISTON Knochensplitterzange, 280 mm

STILLE LISTON Bone cutting forceps, 280 mm

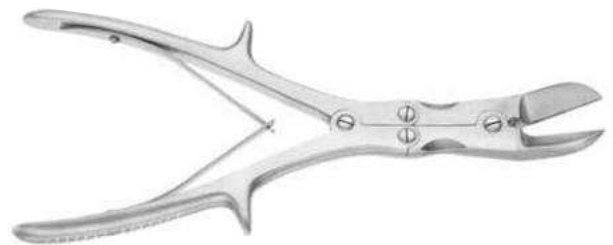
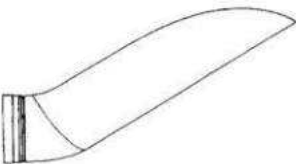

06-15-645 STILLE LISTON Knochensplitterzange, 240 mm

STILLE LISTON Bone cutting forceps, 240 mm

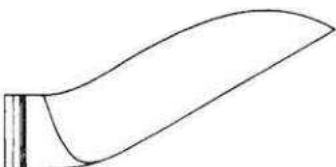

06-15-647 STILLE LISTON Knochensplitterzange, 275 mm

STILLE LISTON Bone cutting forceps, 275 mm

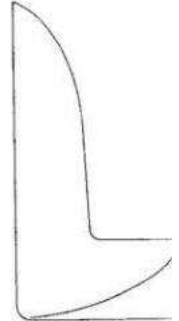

06-15-648 STILLE LISTON Knochensplitterzange, 265 mm

STILLE LISTON Bone cutting forceps, 265 mm

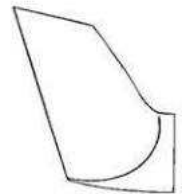

06-15-649 STILLE HORSLEY Knochensplitterzange, 270 mm

STILLE HORSLEY Bone cutting forceps, 270 mm

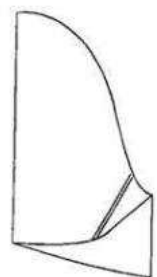

06-65-650 SEMB Knochensplitterzange, 240 mm

SEMB Bone cutting forceps, 240 mm





06-11-801

MARTINI Scharfer Löffel, 140 mm

MARTINI Bone curette, 140 mm



06-11-814

WILLIGER Scharfer Löffel, 145 mm

WILLIGER Bone curette, 145 mm

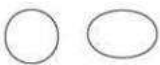

06-11-850

Scharfer Löffel, 210 mm

Bone curette, 210 mm



06-11-840

VOLKMANN Scharfer Löffel, 130 mm

VOLKMANN Bone curette, 130 mm



06-11-841

VOLKMANN Scharfer Löffel, 145 mm

VOLKMANN Bone curette, 145 mm



06-11-842

VOLKMANN Scharfer Löffel, 170 mm

VOLKMANN Bone curette, 170 mm

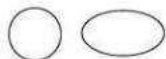

06-11-845

Scharfer Löffel, 130 mm

Bone curette, 130 mm

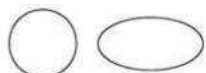

06-11-846

Scharfer Löffel, 160 mm

Bone curette, 160 mm

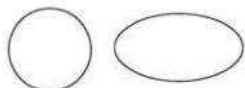

06-11-848

Scharfer Löffel, 200 mm

Bone curette, 200 mm



SPRATT scharfer Löffel

06-61-620	Fig. 0000, 170 mm	
06-61-621	Fig. 000, 170 mm	
06-61-622	Fig. 00, 170 mm	
06-61-623	Fig. 0, 170 mm	
06-61-624	Fig. 1, 170 mm	
06-61-625	Fig. 2, 170 mm	
06-61-626	Fig. 3, 170 mm	
06-61-627	Fig. 4, 170 mm	
06-61-628	Fig. 5, 170 mm	

SPRATT Bone curette

Fig. 0000, 170 mm	
Fig. 000, 170 mm	
Fig. 00, 170 mm	
Fig. 0, 170 mm	
Fig. 1, 170 mm	
Fig. 2, 170 mm	
Fig. 3, 170 mm	
Fig. 4, 170 mm	
Fig. 5, 170 mm	

BRUNS Scharfer Löffel

06-61-610	2,0 mm, 170 mm	
06-11-611	3,0 mm, 170 mm	
06-11-612	4,0 mm, 170 mm	
06-11-613	5,0 mm, 170 mm	
06-11-614	6,0 mm, 170 mm	
06-11-615	8,0 mm, 170 mm	
06-11-616	10,0 mm, 170 mm	
06-11-617	12,0 mm, 170 mm	
06-61-618	14,0 mm, 170 mm	
06-61-619	16,0 mm, 170 mm	

BRUNS Bone curette

2.0 mm, 170 mm	
3.0 mm, 170 mm	
4.0 mm, 170 mm	
5.0 mm, 170 mm	
6.0 mm, 170 mm	
8.0 mm, 170 mm	
10.0 mm, 170 mm	
12.0 mm, 170 mm	
14.0 mm, 170 mm	
16.0 mm, 170 mm	



VOLKMANN Scharfer Löffel

VOLKMANN Bone curette

06-11-630	2,8 mm, 170 mm		2.8 mm, 170 mm	
06-11-631	3,6 mm, 170 mm		3.6 mm, 170 mm	
06-11-632	4,4 mm, 170 mm		4.4 mm, 170 mm	
06-11-633	5,2 mm, 170 mm		5.2 mm, 170 mm	
06-11-634	6,8 mm, 170 mm		6.8 mm, 170 mm	
06-11-635	8,5 mm, 170 mm		8.5 mm, 170 mm	
06-11-636	10,0 mm, 170 mm		10.0 mm, 170 mm	
06-11-637	11,5 mm, 170 mm		11.5 mm, 170 mm	
06-11-638	13,0 mm, 170 mm		13.0 mm, 170 mm	
06-11-639	14,5 mm, 170 mm		14.5 mm, 170 mm	



SCHEDE Scharfer Löffel

SCHEDE Bone curette

06-11-621	2,5 mm, 170 mm		2.5 mm, 170 mm	
06-11-622	3,4 mm, 170 mm		3.4 mm, 170 mm	
06-11-623	4,2 mm, 170 mm		4.2 mm, 170 mm	
06-11-624	5,2 mm, 170 mm		5.2 mm, 170 mm	
06-11-625	6,3 mm, 170 mm		6.3 mm, 170 mm	
06-11-626	7,4 mm, 170 mm		7.4 mm, 170 mm	
06-11-627	8,0 mm, 170 mm		8.0 mm, 170 mm	





	HALLE Scharfer Löffel, biegsam		HALLE Bone curette, malleable	
06-11-684	4,4 mm, 215 mm		4.4 mm, 215 mm	
06-11-685	5,2 mm, 215 mm		5.2 mm, 215 mm	
06-11-686	6,8 mm, 215 mm		6.8 mm, 215 mm	



	SIMON Scharfer Löffel		SIMON Bone curette	
06-11-688	3,6 mm, 235 mm		3.6 mm, 235 mm	
06-11-689	4,4 mm, 235 mm		4.4 mm, 235 mm	
06-11-690	5,2 mm, 235 mm		5.2 mm, 235 mm	



	BRUNS scharfer Löffel		BRUNS Bone curette	
13-02-872	Fig. 000, 230 mm		Fig. 000, 230 mm	
13-02-873	Fig. 00, 230 mm		Fig. 00, 230 mm	
13-02-874	Fig. 0, 230 mm		Fig. 0, 230 mm	
13-02-875	Fig. 1, 230 mm		Fig. 1, 230 mm	
13-02-876	Fig. 2, 230 mm		Fig. 2, 230 mm	
13-02-877	Fig. 3, 230 mm		Fig. 3, 230 mm	
13-02-878	Fig. 4, 230 mm		Fig. 4, 230 mm	
13-02-879	Fig. 5, 230 mm		Fig. 5, 230 mm	
13-02-880	Fig. 6, 230 mm		Fig. 6, 230 mm	



DAUBENSPECK Scharfer Löffel

DAUBENSPECK Bone curette

06-11-662	2,8 mm, 200 mm		2.8 mm, 200 mm	
06-11-663	3,6 mm, 200 mm		3.6 mm, 200 mm	
06-11-664	4,4 mm, 200 mm		4.4 mm, 200 mm	
06-11-665	5,2 mm, 200 mm		5.2 mm, 200 mm	



LEMPERT Scharfer Löffel, gerade

LEMPERT Bone curette, straight

06-11-675	1,8 mm, 215 mm		1.8 mm, 215 mm	
06-11-676	2,0 mm, 215 mm		2.0 mm, 215 mm	
06-11-677	2,4 mm, 215 mm		2.4 mm, 215 mm	
06-11-678	2,6 mm, 215 mm		2.6 mm, 215 mm	
06-11-679	2,8 mm, 215 mm		2.8 mm, 215 mm	



LEMPERT Scharfer Löffel, gewinkelt

LEMPERT Bone curette, angled

06-61-675	1,8 mm, 215 mm		1.8 mm, 215 mm	
06-61-676	2,0 mm, 215 mm		2.0 mm, 215 mm	
06-61-677	2,4 mm, 215 mm		2.4 mm, 215 mm	
06-61-678	2,6 mm, 215 mm		2.6 mm, 215 mm	
06-61-679	2,8 mm, 215 mm		2.8 mm, 215 mm	



BUSHE Scharfer Löffel, rückwärts gebogen

BUSHE Bone curette, curved backward

06-11-723	3,0 mm, 250 mm		3.0 mm, 250 mm	
06-11-724	4,0 mm, 250 mm		4.0 mm, 250 mm	
06-11-725	5,0 mm, 250 mm		5.0 mm, 250 mm	





Scharfer Löffel, gerade

Bone curette, straight

06-11-702	3,6 mm, 250 mm		3.6 mm, 250 mm	
06-11-703	4,4 mm, 250 mm		4.4 mm, 250 mm	
06-11-704	5,2 mm, 250 mm		5.2 mm, 250 mm	
06-11-705	6,8 mm, 250 mm		6.8 mm, 250 mm	



Scharfer Löffel, gewinkelt

Bone curette, angled

06-11-712	3,6 mm, 250 mm		3.6 mm, 250 mm	
06-11-713	4,4 mm, 250 mm		4.4 mm, 250 mm	
06-11-714	5,2 mm, 250 mm		5.2 mm, 250 mm	
06-11-715	6,8 mm, 250 mm		6.8 mm, 250 mm	



CASPAR Scharfer Löffel, gerade

CASPAR Bone curette, straight

06-11-773	3,6 mm, 220 mm		3.6 mm, 220 mm	
06-11-774	4,4 mm, 220 mm		4.4 mm, 220 mm	
06-11-775	5,2 mm, 220 mm		5.2 mm, 220 mm	



CASPAR Scharfer Löffel, gewinkelt

CASPAR Bone curette, angled

06-11-783	3,6 mm, 220 mm		3.6 mm, 220 mm	
06-11-784	4,4 mm, 220 mm		4.4 mm, 220 mm	
06-11-785	5,2 mm, 220 mm		5.2 mm, 220 mm	



CASPAR Kürette, gezahnt		CASPAR Curette, toothed	
06-11-834	4 mm, 220 mm		4 mm, 220 mm
06-11-835	5 mm, 220 mm		5 mm, 220 mm
06-11-836	6 mm, 220 mm		5 mm, 220 mm

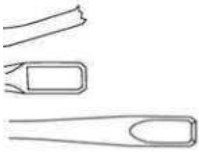

06-11-854	CASPAR Kürette, gezahnt, 4,0 mm, 250 mm	CASPAR Curette, toothed, 4.0 mm, 250 mm
-----------	---	---

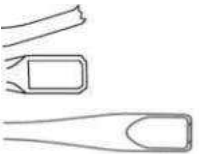

06-11-855	CASPAR Kürette, gezahnt, 5,0 mm, 250 mm	CASPAR Curette, toothed, 5.0 mm, 250 mm
-----------	---	---

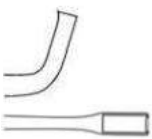

06-11-863	CASPAR Kürette, gezahnt, 3,0 mm, 270 mm	CASPAR Curette, toothed, 3.0 mm, 270 mm
-----------	---	---



06-11-864	CASPAR Kürette, gezahnt, 4,0 mm, 270 mm	CASPAR Curette, toothed, 4.0 mm, 270 mm
-----------	---	---



**COBB Kürette, gerade****COBB Curette, straight**

06-61-880	3,25 mm, 280 mm		3.25 mm, 280 mm	
06-61-881	4,0 mm, 280 mm		4.0 mm, 280 mm	
06-61-882	5,0 mm, 280 mm		5.0 mm, 280 mm	
06-61-883	6,0 mm, 280 mm		6.0 mm, 280 mm	
06-61-884	7,5 mm, 280 mm		7.5 mm, 280 mm	
06-61-885	9,0 mm, 280 mm		9.0 mm, 280 mm	
06-61-886	11,5 mm, 280 mm		11.5 mm, 280 mm	
06-61-887	13,0 mm, 280 mm		13.0 mm, 280 mm	
06-61-888	15,5 mm, 280 mm		15.5 mm, 280 mm	

**COBB Kürette, gewinkelt****COBB Curette, angled**

06-61-890	3,25 mm, 280 mm		3.25 mm, 280 mm	
06-61-891	4,0 mm, 280 mm		4.0 mm, 280 mm	
06-61-892	5,0 mm, 280 mm		5.0 mm, 280 mm	
06-61-893	6,0 mm, 280 mm		6.0 mm, 280 mm	
06-61-894	7,5 mm, 280 mm		7.5 mm, 280 mm	
06-61-895	9,0 mm, 280 mm		9.0 mm, 280 mm	
06-61-896	11,5 mm, 280 mm		11.5 mm, 280 mm	
06-61-897	13,0 mm, 280 mm		13.0 mm, 280 mm	
06-61-898	15,5 mm, 280 mm		15.5 mm, 280 mm	



CONE Kürette, gerade

CONE Curette, straight

06-61-870	4 mm, 230 mm		4 mm, 230 mm	
06-61-871	7 mm, 230 mm		7 mm, 230 mm	
06-61-872	9 mm, 230 mm		9 mm, 230 mm	



CONE Kürette, gewinkelt

CONE Curette, angled

06-61-873	4 mm, 230 mm		4 mm, 230 mm	
06-61-874	7 mm, 230 mm		7 mm, 230 mm	
06-61-875	9 mm, 230 mm		9 mm, 230 mm	





COTTLE Osteotom, graduiert

15-12-294	4 mm, 180 mm
15-12-296	6 mm, 180 mm
15-12-298	8 mm, 180 mm
15-12-299	10 mm, 180 mm
15-12-300	12 mm, 180 mm

COTTLE Osteotome, with depth markings

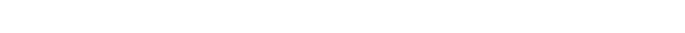
4 mm, 180 mm
6 mm, 180 mm
8 mm, 180 mm
10 mm, 180 mm
12 mm, 180 mm

COTTLE Flachmeißel, graduiert

15-12-301	4 mm, 180 mm
15-12-302	6 mm, 180 mm
15-12-303	8 mm, 180 mm
15-62-300	10 mm, 180 mm
15-12-304	12 mm, 180 mm

COTTLE Chisel, with depth markings

4 mm, 180 mm
6 mm, 180 mm
8 mm, 180 mm
10 mm, 180 mm
12 mm, 180 mm

COTTLE Osteotom, graduiert

15-62-301	4 mm, 180 mm
15-62-302	6 mm, 180 mm
15-62-303	8 mm, 180 mm
15-62-304	10 mm, 180 mm
15-62-305	12 mm, 180 mm

COTTLE Osteotome, with depth markings

4 mm, 180 mm
6 mm, 180 mm
8 mm, 180 mm
10 mm, 180 mm
12 mm, 180 mm

15-12-307 COTTLE Fischschwanzosteotom, graduiert, 8 mm, 180 mm
COTTLE Fishtail osteotome, with depth markings, 8 mm, 180 mm

04-15-720 OBWEGESER Osteotom, gebogen, 11 mm, 235 mm
OBWEGESER Osteotome, curved, 11 mm, 235 mm



MINI LAMBOTTE Osteotom

06-62-099	2 mm, 125 mm
06-62-100	3 mm, 125 mm
06-12-101	4 mm, 125 mm
06-12-102	6 mm, 125 mm
06-12-104	8 mm, 125 mm
06-12-106	10 mm, 125 mm
06-12-108	12 mm, 125 mm
06-12-109	15 mm, 125 mm
06-62-110	18 mm, 125 mm
06-62-111	19 mm, 125 mm
06-62-112	20 mm, 125 mm

MINI LAMBOTTE Osteotome

2 mm, 125 mm
3 mm, 125 mm
4 mm, 125 mm
6 mm, 125 mm
8 mm, 125 mm
10 mm, 125 mm
12 mm, 125 mm
15 mm, 125 mm
18 mm, 125 mm
19 mm, 125 mm
20 mm, 125 mm

LAMBOTTE Osteotom

06-62-113	3 mm, 170 mm
06-62-114	4 mm, 170 mm
06-62-116	6 mm, 170 mm
06-62-118	8 mm, 170 mm
06-62-120	10 mm, 170 mm
06-62-122	12 mm, 170 mm
06-62-126	15 mm, 170 mm

LAMBOTTE Osteotome

3 mm, 170 mm
4 mm, 170 mm
6 mm, 170 mm
8 mm, 170 mm
10 mm, 170 mm
12 mm, 170 mm
15 mm, 170 mm



LAMBOTTE Osteotom

06-12-650	4 mm, 245 mm
06-12-651	8 mm, 245 mm
06-12-652	10 mm, 245 mm
06-12-653	13 mm, 245 mm
06-12-654	15 mm, 245 mm
06-12-655	18 mm, 245 mm
06-12-656	20 mm, 245 mm
06-12-658	25 mm, 245 mm
06-12-659	30 mm, 245 mm
06-12-660	38 mm, 245 mm
06-12-661	44 mm, 245 mm
06-12-662	50 mm, 245 mm

LAMBOTTE Osteotome

4 mm, 245 mm
8 mm, 245 mm
10 mm, 245 mm
13 mm, 245 mm
15 mm, 245 mm
18 mm, 245 mm
20 mm, 245 mm
25 mm, 245 mm
30 mm, 245 mm
38 mm, 245 mm
44 mm, 245 mm
50 mm, 245 mm

LAMBOTTE Osteotom, gebogen

06-62-780	4 mm, 245 mm
06-12-781	8 mm, 245 mm
06-62-782	10 mm, 245 mm
06-12-783	13 mm, 245 mm
06-62-784	15 mm, 245 mm
06-12-785	18 mm, 245 mm
06-62-786	20 mm, 245 mm
06-12-788	25 mm, 245 mm
06-12-789	30 mm, 245 mm
06-12-790	38 mm, 245 mm
06-62-791	44 mm, 245 mm
06-62-792	50 mm, 245 mm

LAMBOTTE Osteotome, curved

4 mm, 245 mm
8 mm, 245 mm
10 mm, 245 mm
13 mm, 245 mm
15 mm, 245 mm
18 mm, 245 mm
20 mm, 245 mm
25 mm, 245 mm
30 mm, 245 mm
38 mm, 245 mm
44 mm, 245 mm
50 mm, 245 mm





LUCAS Flachmeißel

LUCAS Chisel

04-15-711	4 mm, 160 mm	4 mm, 160 mm
04-15-713	6 mm, 160 mm	6 mm, 160 mm



LUCAS Hohlmeißel

LUCAS Gouge

04-15-715	3 mm, 160 mm	3 mm, 160 mm
04-15-717	5 mm, 160 mm	5 mm, 160 mm



HOKE Osteotom

HOKE Osteotome

06-62-140	3 mm, 170 mm	3 mm, 170 mm
06-62-141	5 mm, 170 mm	5 mm, 170 mm
06-62-142	6 mm, 170 mm	6 mm, 170 mm
06-62-143	8 mm, 170 mm	8 mm, 170 mm
06-62-144	9 mm, 170 mm	9 mm, 170 mm



**Osteotom**

06-12-110	4 mm, 135 mm
06-12-112	6 mm, 135 mm
06-12-114	8 mm, 135 mm
06-12-116	10 mm, 135 mm
06-12-118	12 mm, 135 mm
06-62-130	14 mm, 135 mm
06-62-131	16 mm, 135 mm

Osteotome

4 mm, 135 mm
6 mm, 135 mm
8 mm, 135 mm
10 mm, 135 mm
12 mm, 135 mm
14 mm, 135 mm
16 mm, 135 mm

**Flachmeißel**

06-12-120	4 mm, 135 mm
06-12-122	6 mm, 135 mm
06-12-124	8 mm, 135 mm
06-12-126	10 mm, 135 mm
06-12-128	12 mm, 135 mm
06-62-132	14 mm, 135 mm
06-62-133	16 mm, 135 mm

Chisel

4 mm, 135 mm
6 mm, 135 mm
8 mm, 135 mm
10 mm, 135 mm
12 mm, 135 mm
14 mm, 135 mm
16 mm, 135 mm

**Hohlmeißel**

06-12-130	4 mm, 135 mm
06-12-132	6 mm, 135 mm
06-12-134	8 mm, 135 mm
06-12-136	10 mm, 135 mm
06-12-138	12 mm, 135 mm
06-62-134	14 mm, 135 mm
06-62-135	16 mm, 135 mm

Gouge

4 mm, 135 mm
6 mm, 135 mm
8 mm, 135 mm
10 mm, 135 mm
12 mm, 135 mm
14 mm, 135 mm
16 mm, 135 mm





ALEXANDER Flachmeißel

06-62-340	4 mm, 180 mm
06-62-341	6 mm, 180 mm
06-62-342	8 mm, 180 mm
06-62-343	10 mm, 180 mm
06-62-344	12 mm, 180 mm
06-62-345	14 mm, 180 mm

ALEXANDER Chisel

6 mm, 180 mm
6 mm, 180 mm
8 mm, 180 mm
10 mm, 180 mm
12 mm, 180 mm
14 mm, 180 mm



ALEXANDER Hohlmeißel

06-12-341	4 mm, 180 mm
06-12-343	6 mm, 180 mm
06-12-345	8 mm, 180 mm
06-12-347	10 mm, 180 mm
06-62-349	12 mm, 180 mm
06-62-351	14 mm, 180 mm

ALEXANDER Gouge

4 mm, 180 mm
6 mm, 180 mm
8 mm, 180 mm
10 mm, 180 mm
12 mm, 180 mm
14 mm, 180 mm



PARTSCH Flachmeißel

06-62-182	2 mm, 170 mm
06-12-183	3 mm, 170 mm
06-12-184	4 mm, 170 mm
06-12-185	5 mm, 170 mm
06-12-186	6 mm, 170 mm
06-12-187	7 mm, 170 mm
06-62-188	8 mm, 170 mm

PARTSCH Chisel

2 mm, 170 mm
3 mm, 170 mm
4 mm, 170 mm
5 mm, 170 mm
6 mm, 170 mm
7 mm, 170 mm
8 mm, 170 mm



PARTSCH Hohlmeißel

06-62-222	2 mm, 170 mm
06-12-223	3 mm, 170 mm
06-12-224	4 mm, 170 mm
06-12-225	5 mm, 170 mm
06-12-226	6 mm, 170 mm
06-12-227	7 mm, 170 mm
06-62-228	8 mm, 170 mm

PARTSCH Gouge

2 mm, 170 mm
3 mm, 170 mm
4 mm, 170 mm
5 mm, 170 mm
6 mm, 170 mm
7 mm, 170 mm
8 mm, 170 mm



**STILLE Osteotom**

06-62-511	6 mm, 205 mm
06-12-512	8 mm, 205 mm
06-12-513	10 mm, 205 mm
06-12-514	12 mm, 205 mm
06-12-515	15 mm, 205 mm
06-12-516	20 mm, 205 mm
06-12-517	25 mm, 205 mm
06-62-518	30 mm, 205 mm

STILLE Osteotome

6 mm, 205 mm
8 mm, 205 mm
10 mm, 205 mm
12 mm, 205 mm
15 mm, 205 mm
20 mm, 205 mm
25 mm, 205 mm
30 mm, 205 mm

STILLE Osteotom

06-12-523	10 mm, 205 mm
06-12-524	12 mm, 205 mm
06-12-525	15 mm, 205 mm
06-12-526	20 mm, 205 mm
06-12-527	25 mm, 205 mm

STILLE Osteotome

10 mm, 205 mm
12 mm, 205 mm
15 mm, 205 mm
20 mm, 205 mm
25 mm, 205 mm

**STILLE Osteotom, gebogen**

06-12-553	10 mm, 205 mm
06-12-554	12 mm, 205 mm
06-12-555	15 mm, 205 mm
06-12-556	20 mm, 205 mm
06-12-557	25 mm, 205 mm

STILLE Osteotome, curved

10 mm, 205 mm
12 mm, 205 mm
15 mm, 205 mm
20 mm, 205 mm
25 mm, 205 mm

**STILLE Flachmeißel**

06-62-501	6 mm, 205 mm
06-62-502	8 mm, 205 mm
06-12-503	10 mm, 205 mm
06-12-504	12 mm, 205 mm
06-12-505	15 mm, 205 mm
06-12-506	20 mm, 205 mm
06-12-507	25 mm, 205 mm
06-62-508	30 mm, 205 mm

STILLE Chisel

6 mm, 205 mm
8 mm, 205 mm
10 mm, 205 mm
12 mm, 205 mm
15 mm, 205 mm
20 mm, 205 mm
25 mm, 205 mm
30 mm, 205 mm



STILLE Hohlmeißel

STILLE Gouge

06-62-571	6 mm, 205 mm	6 mm, 205 mm
06-62-572	8 mm, 205 mm	8 mm, 205 mm
06-12-573	10 mm, 205 mm	10 mm, 205 mm
06-12-574	12 mm, 205 mm	12 mm, 205 mm
06-12-575	15 mm, 205 mm	15 mm, 205 mm
06-12-576	20 mm, 205 mm	20 mm, 205 mm
06-12-577	25 mm, 205 mm	25 mm, 205 mm



LEXER-MINI Osteotom

LEXER-MINI Osteotome

06-12-380	4 mm, 180 mm	4 mm, 180 mm
06-12-381	6 mm, 180 mm	6 mm, 180 mm
06-12-382	8 mm, 180 mm	8 mm, 180 mm
06-12-383	10 mm, 180 mm	10 mm, 180 mm
06-12-384	12 mm, 180 mm	12 mm, 180 mm

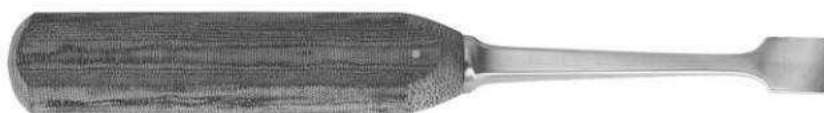
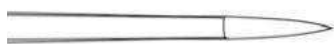

LEXER Osteotom

LEXER Osteotome

06-12-401	5 mm, 220 mm	5 mm, 220 mm
06-12-402	7 mm, 220 mm	7 mm, 220 mm
06-12-403	10 mm, 220 mm	10 mm, 220 mm
06-12-405	15 mm, 220 mm	15 mm, 220 mm
06-12-406	20 mm, 220 mm	20 mm, 220 mm
06-12-407	25 mm, 220 mm	25 mm, 220 mm
06-12-408	30 mm, 220 mm	30 mm, 220 mm



LEXER Hohlmeißel

LEXER Gouge

06-12-411	5 mm, 220 mm	5 mm, 220 mm
06-12-412	7 mm, 220 mm	7 mm, 220 mm
06-12-413	10 mm, 220 mm	10 mm, 220 mm
06-12-415	15 mm, 220 mm	15 mm, 220 mm
06-12-416	20 mm, 220 mm	20 mm, 220 mm
06-12-417	25 mm, 220 mm	25 mm, 220 mm
06-12-418	30 mm, 220 mm	30 mm, 220 mm



**Hohlmeißel**

06-12-431	5 mm, gerade, 250 mm
06-12-433	10 mm, gerade, 250 mm
06-12-435	15 mm, gerade, 250 mm

Gouge

5 mm, straight, 250 mm
10 mm, straight, 250 mm
15 mm, straight, 250 mm

**Hohlmeißel**

06-12-441	5 mm, gebogen, 250 mm
06-12-443	10 mm, gebogen, 250 mm
06-12-445	15 mm, gebogen, 250 mm

Gouge

5 mm, curved, 250 mm
10 mm, curved, 250 mm
15 mm, curved, 250 mm

**HIBBS Flachmeißel, gerade**

13-52-670	6 mm, 240 mm
13-52-671	10 mm, 240 mm
13-52-672	13 mm, 240 mm
13-52-673	16 mm, 240 mm
13-52-674	19 mm, 240 mm
13-52-675	22 mm, 240 mm
13-52-676	25 mm, 240 mm
13-52-677	28 mm, 240 mm
13-52-678	32 mm, 240 mm
13-52-679	38 mm, 240 mm

HIBBS Chisel, straight

6 mm, 240 mm
10 mm, 240 mm
13 mm, 240 mm
16 mm, 240 mm
19 mm, 240 mm
22 mm, 240 mm
25 mm, 240 mm
28 mm, 240 mm
32 mm, 240 mm
38 mm, 240 mm

**HIBBS Osteotom, gerade**

13-02-675	6 mm, 240 mm
13-02-676	10 mm, 240 mm
13-02-677	13 mm, 240 mm
13-02-678	16 mm, 240 mm
13-02-679	19 mm, 240 mm
13-02-680	22 mm, 240 mm
13-02-681	25 mm, 240 mm
13-02-682	28 mm, 240 mm
13-02-683	32 mm, 240 mm
13-02-684	38 mm, 240 mm

HIBBS Osteotome, straight

6 mm, 240 mm
10 mm, 240 mm
13 mm, 240 mm
16 mm, 240 mm
19 mm, 240 mm
22 mm, 240 mm
25 mm, 240 mm
28 mm, 240 mm
32 mm, 240 mm
38 mm, 240 mm



HIBBS Osteotom, gebogen

HIBBS Osteotome, curved

13-02-685	6 mm, 240 mm	6 mm, 240 mm
13-02-686	10 mm, 240 mm	10 mm, 240 mm
13-02-687	13 mm, 240 mm	13 mm, 240 mm
13-02-688	16 mm, 240 mm	16 mm, 240 mm
13-02-689	19 mm, 240 mm	19 mm, 240 mm
13-02-690	22 mm, 240 mm	22 mm, 240 mm
13-02-691	25 mm, 240 mm	25 mm, 240 mm
13-02-692	28 mm, 240 mm	28 mm, 240 mm
13-02-693	32 mm, 240 mm	32 mm, 240 mm
13-02-694	38 mm, 240 mm	38 mm, 240 mm

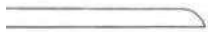

HIBBS Hohlmeißel, gerade

HIBBS Gouge, straight

13-52-706	6 mm, 240 mm	6 mm, 240 mm
13-52-707	10 mm, 240 mm	10 mm, 240 mm
13-52-708	13 mm, 240 mm	13 mm, 240 mm
13-02-709	16 mm, 240 mm	16 mm, 240 mm
13-02-710	19 mm, 240 mm	19 mm, 240 mm
13-02-711	22 mm, 240 mm	22 mm, 240 mm
13-02-712	25 mm, 240 mm	25 mm, 240 mm
13-02-713	28 mm, 240 mm	28 mm, 240 mm
13-02-714	32 mm, 240 mm	32 mm, 240 mm
13-02-715	38 mm, 240 mm	38 mm, 240 mm



HIBBS Hohlmeißel, gebogen

HIBBS Gouge, curved

13-02-716	6 mm, 240 mm	6 mm, 240 mm
13-02-717	10 mm, 240 mm	10 mm, 240 mm
13-02-718	13 mm, 240 mm	13 mm, 240 mm
13-02-719	16 mm, 240 mm	16 mm, 240 mm
13-02-720	19 mm, 240 mm	19 mm, 240 mm
13-52-720	22 mm, 240 mm	22 mm, 240 mm
13-02-721	25 mm, 240 mm	25 mm, 240 mm
13-02-722	28 mm, 240 mm	28 mm, 240 mm
13-52-722	32 mm, 240 mm	32 mm, 240 mm
13-02-723	38 mm, 240 mm	38 mm, 240 mm



SMITH PETERSEN Osteotom, gerade

13-02-657	6 mm, 200 mm
13-02-658	9 mm, 200 mm
13-02-659	13 mm, 200 mm
13-02-660	16 mm, 200 mm
13-02-661	19 mm, 200 mm
13-02-662	25 mm, 200 mm
13-52-663	32 mm, 200 mm

SMITH PETERSEN Osteotome, straight

6 mm, 200 mm
9 mm, 200 mm
13 mm, 200 mm
16 mm, 200 mm
19 mm, 200 mm
25 mm, 200 mm
32 mm, 200 mm

SMITH PETERSEN Osteotom, gebogen

13-02-663	6 mm, 200 mm
13-02-664	9 mm, 200 mm
13-02-665	13 mm, 200 mm
13-02-666	16 mm, 200 mm
13-02-667	19 mm, 200 mm
13-02-668	25 mm, 200 mm
13-02-669	32 mm, 200 mm

SMITH PETERSEN Osteotome, curved

6 mm, 200 mm
9 mm, 200 mm
13 mm, 200 mm
16 mm, 200 mm
19 mm, 200 mm
25 mm, 200 mm
32 mm, 200 mm

SMITH PETERSEN Hohlmeißel, gerade

13-06-465	6 mm, 200 mm
13-06-466	9 mm, 200 mm
13-06-467	13 mm, 200 mm
13-06-468	16 mm, 200 mm
13-06-469	19 mm, 200 mm
13-06-470	25 mm, 200 mm
13-56-471	32 mm, 200 mm

SMITH PETERSEN Gouge, straight

6 mm, 200 mm
9 mm, 200 mm
13 mm, 200 mm
16 mm, 200 mm
19 mm, 200 mm
25 mm, 200 mm
32 mm, 200 mm

SMITH PETERSEN Hohlmeißel, gebogen

13-06-472	6 mm, 200 mm
13-06-473	9 mm, 200 mm
13-06-474	13 mm, 200 mm
13-06-475	16 mm, 200 mm
13-06-476	19 mm, 200 mm
13-06-477	25 mm, 200 mm
13-06-478	32 mm, 200 mm

SMITH PETERSEN Gouge, curved

6 mm, 200 mm
9 mm, 200 mm
13 mm, 200 mm
16 mm, 200 mm
19 mm, 200 mm
25 mm, 200 mm
32 mm, 200 mm



Wirbelsäulenmeißel, bajonettförmig

Lamina gouge, cranked

06-12-437	6 mm, 235 mm	6 mm, 235 mm
06-12-438	8 mm, 235 mm	8 mm, 235 mm
06-12-439	11 mm, 235 mm	11 mm, 235 mm
06-12-440	16 mm, 235 mm	16 mm, 235 mm



ZIELKE Hohlmeißel, gebogen

ZIELKE Gouge, curved

06-12-701	5,5 mm, 230 mm	5.5 mm, 230 mm
06-12-702	9 mm, 230 mm	9 mm, 230 mm



06-62-705 COBB Hohlmeißel, gerade, 280 mm

COBB Gouge, straight, 280 mm



06-62-706 COBB Hohlmeißel, leicht gebogen, 280 mm

COBB Gouge, slightly curved, 280 mm



06-62-707 COBB Hohlmeißel, stark gebogen, 280 mm

COBB Gouge, strongly curved, 280 mm



06-62-708 COBB Hohlmeißel, rückwärts gebogen, 280 mm

COBB Gouge, curved backward, 280 mm

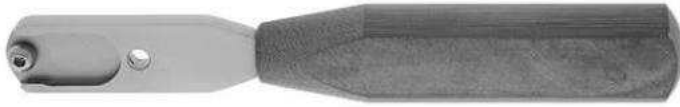

06-12-665 Meißelgriff für auswechselbare Klingen

Handle for interchangeable blades

Auswechselbare Klinge
Interchangeable blade

	Auswechselbare Klinge	<i>Interchangeable blade</i>
06-12-666	5 mm	<i>5 mm</i>
06-12-668	10 mm	<i>10 mm</i>
06-12-670	16 mm	<i>16 mm</i>
06-12-672	25 mm	<i>25 mm</i>



07-02-020 Schlüssel für Meißelgriff 06-12-665

Key for chisel handle 06-12-665

TC



15-12-421 Raspel, Hartmetall-Zähne, Fig. 1/2, 205 mm

Rasp, carbide teeth, Fig. 1/2, 205 mm

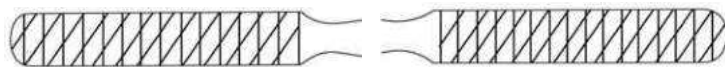

15-12-423 Raspel, Hartmetall-Zähne, Fig. 3/4, 205 mm

Rasp, carbide teeth, Fig. 3/4, 205 mm



15-12-425 Raspel, Hartmetall-Zähne, Fig. 5/6, 205 mm

Rasp, carbide teeth, Fig. 5/6, 205 mm



15-12-427 Raspel, Hartmetall-Zähne, Fig. 7/8, 205 mm

Rasp, carbide teeth, Fig. 7/8, 205 mm

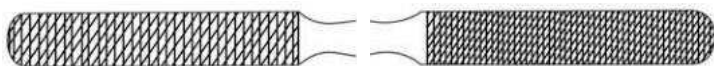

15-12-429 Raspel, Hartmetall-Zähne, Fig. 9/10, 205 mm

Rasp, carbide teeth, Fig. 9/10, 205 mm



06-11-505 PUTTI Raspel, 270 mm

PUTTI Rasp, 270 mm



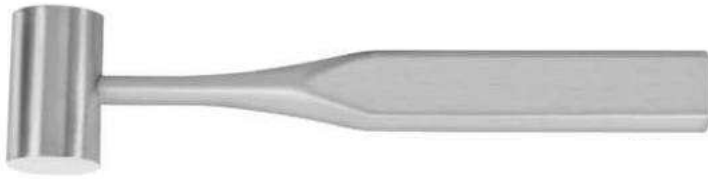

06-12-038	COTTLE Hammer Ø 30 mm, flach/convex, 240 g, 180 mm	COTTLE Mallet Ø 30 mm, flat/convex, 240 g, 180 mm
-----------	--	---



06-12-044	HAJEK Hammer Ø 27 mm, 130 g, 220 mm	HAJEK Mallet Ø 27 mm, 130 g, 220 mm
-----------	---	---



	Hammer	Mallet
06-62-710	Ø 35 mm, 450 g, 265 mm	Ø 35 mm, 450 g, 265 mm
06-62-711	Ø 50 mm, 900 g, 265 mm	Ø 50 mm, 900 g, 265 mm
06-62-712	Ø 55 mm, 1300 g, 265 mm	Ø 55 mm, 1300 g, 265 mm



06-12-036	Hammer , Ø 25 mm, 135 g, 185 mm	Mallet , Ø 25 mm, 135 g, 185 mm
06-12-037	Ersatzbacken für 06-12-036, Paar	Spare discs for 06-12-036, pair



06-02-918	LEBSCHER Sternummeißel , 245 mm	LEBSCHER Sternum chisel , 245 mm
-----------	--	---



04-06-112 Hammer, Ø 22 mm, 80 g, 165 mm

Mallet, Ø 22 mm, 80 g, 165 mm



04-06-114 Hammer, Ø 22 mm, 155 g, 190 mm

Mallet, Ø 22 mm, 155 g, 190 mm



06-12-035 MEAD Hammer mit auswechselbaren Kunststoffbacken,
Ø 20 mm, 180 g, 190 mm

MEAD Mallet with interchangeable plastic discs,
Ø 20 mm, 180 g, 190 mm

06-12-034 Paar Ersatzbacken für 06-12-035

Pair of spare discs for 06-12-035



06-12-045 Hammer mit auswechselbaren Kunststoffbacken,
Ø 30 mm, 200 g, 250 mm

Mallet with interchangeable plastic discs,
Ø 30 mm, 200 g, 250 mm

06-12-047 Paar Ersatzbacken für 06-12-045

Pair of spare discs for 06-12-045



06-62-700 GERZOG Hammer, Ø 25 mm, 250 g, 180 mm

GERZOG Mallet, Ø 25 mm, 250 g, 180 mm





	Hammer	Mallet
06-62-701	350 g	350 g
06-62-702	500 g	500 g
06-62-703	700 g	700 g



06-12-010	Ferrozell Hammer, Ø 42 mm, 250 mm	Ferrozell mallet, Ø 42 mm, 250 mm
-----------	-----------------------------------	-----------------------------------



06-62-704	Ferrozell Hammer, Ø 30 mm, 180 mm	Ferrozell mallet, Ø 30 mm, 180 mm
-----------	-----------------------------------	-----------------------------------



06-62-713	LUCAE Hammer, Ø 19 mm, 230 g, 190 mm	LUCAE Mallet, Ø 19 mm, 230 g, 190 mm
06-62-714	LUCAE Hammer, Ø 25 mm, 260 g, 190 mm	LUCAE Mallet, Ø 25 mm, 260 g, 190 mm

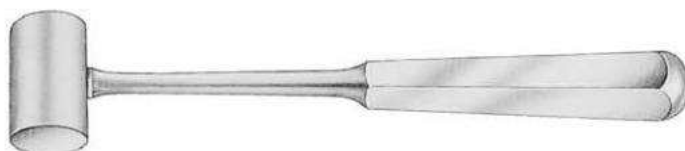

06-62-715	PARTSCH Hammer, Ø 22 mm, 200 g, 180 mm	PARTSCH Mallet, Ø 22 mm, 200 g, 180 mm
-----------	--	--



06-62-719 Hammer, 150 g, 200 mm

Mallet, 150 g, 200 mm

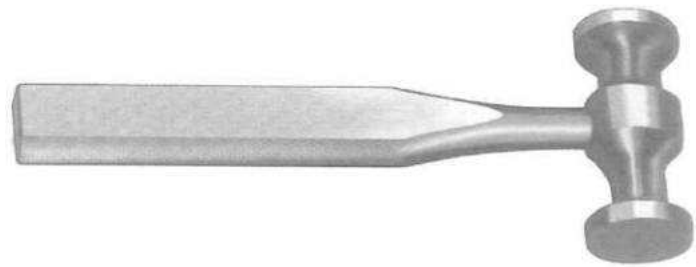

06-62-720 Hammer, 240 g, 180 mm, Stahl

Mallet, 240 g, 180 mm, Steel



06-62-721 Hammer, 120 g, 190 mm, Stahl

Mallet, 120 g, 190 mm, Steel



WILLIGER Hammer

WILLIGER Mallet

06-62-716	Ø 26 mm, 300 g, 240 mm	Ø 26 mm, 300 g, 240 mm
06-62-717	Ø 28 mm, 340 g, 240 mm	Ø 28 mm, 340 g, 240 mm
06-62-718	Ø 30 mm, 400 g, 240 mm	Ø 30 mm, 400 g, 240 mm



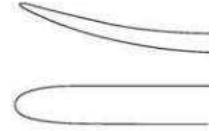

06-11-120 WILLIGER Elevatorium, 5,0 mm, 165 mm

WILLIGER Elevator, 5.0 mm, 165 mm

06-11-121 WILLIGER Elevatorium, 5,5 mm, 170 mm

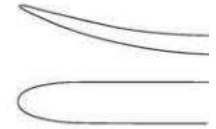
WILLIGER Elevator, 5.5 mm, 170 mm

15-13-307 KÖNIG Elevatorium, 4,5 mm, 155 mm

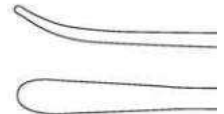
KÖNIG Elevator, 4.5 mm, 155 mm

15-13-308 KÖNIG Elevatorium, 4,5 mm, 155 mm

KÖNIG Elevator, 4.5 mm, 155 mm

06-11-110 Knochenhebel, 5,5 mm, 155 mm

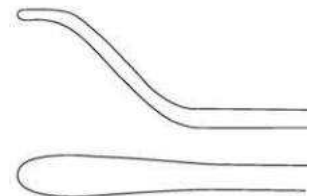
Bone lever, 5.5 mm, 155 mm

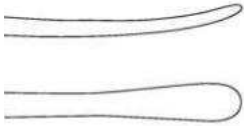

06-11-124 SEBILEAU Elevatorium, 5,0 mm, 175 mm



SEBILEAU Elevator, 5.0 mm, 175 mm

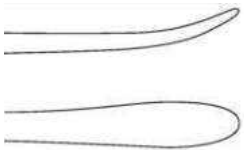

06-11-133 QUERVAIN Elevatorium, 6,0 mm, 195 mm

QUERVAIN Elevator, 6.0 mm, 195 mm

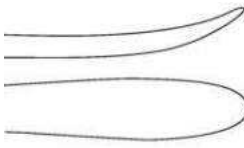

06-11-130 LANGENBECK Elevatorium, 8,0 mm, 195 mm

LANGENBECK Elevator, 8.0 mm, 195 mm

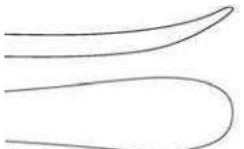

06-11-131 LANGENBECK Elevatorium, 10,0 mm, 195 mm

LANGENBECK Elevator, 10.0 mm, 195 mm

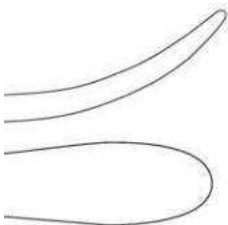

06-11-139 LANGENBECK Elevatorium 11,0 mm, 230 mm



LANGENBECK Elevator, 11.0 mm, 230 mm





06-61-151 LANE Elevatorium, 10 mm, stumpf, 200 mm

LANE Elevator, 10 mm, blunt, 200 mm

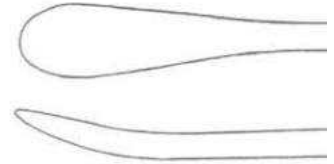

06-61-152 LANE Elevatorium, 6 mm, stumpf, 200 mm

LANE Elevator, 6 mm, blunt, 200 mm

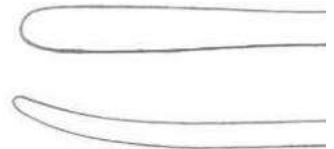

06-61-153 CUSHING Elevatorium, 16 mm, 190 mm

CUSHING Elevator, 16 mm, 190 mm

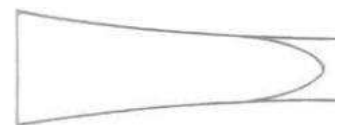

06-61-154 CUSHING Elevatorium, 16 mm, 190 mm

CUSHING Elevator, 16 mm, 190 mm

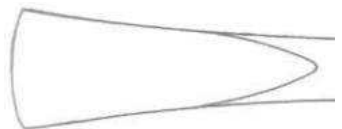

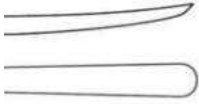

04-15-510 WILLIGER Raspatorium, 4,2 mm, 140 mm



WILLIGER Raspatory, 4.2 mm, 140 mm

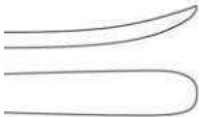

06-11-300 WILLIGER Raspatorium, 6,0 mm, 160 mm

WILLIGER Raspatory, 6.0 mm, 160 mm

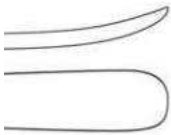

06-11-303 WILLIGER Raspatorium, 8,0 mm, 160 mm

WILLIGER Raspatory, 8.0 mm, 160 mm

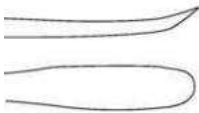

15-13-309 KÖNIG Raspatorium, 5,0 mm, 155 mm



KÖNIG Raspatory, 5.0 mm, 155 mm

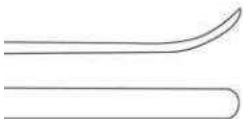

15-12-192 MC KENTY Raspatorium, 4,4 mm, 155 mm



MC KENTY Raspatory, 4.4 mm, 155 mm

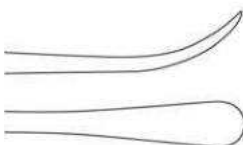

15-12-198 SEWALL Raspatorium, stumpf, 6,0 mm, 200 mm



SEWALL Raspatory, blunt, 6.0 mm, 200 mm



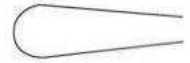

06-61-311 HOEN Raspatorium, 7,0 mm, 160 mm

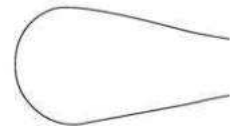
HOEN Raspatory, 7.0 mm, 160 mm

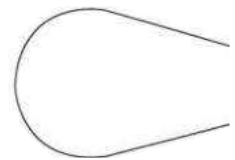
06-61-312 HOEN Raspatorium, 15,0 mm, 190 mm

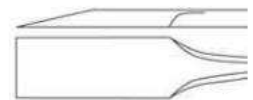
HOEN Raspatory, 15.0 mm, 190 mm

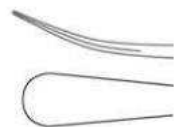
06-61-313 HOEN Raspatorium, 20,0 mm, 190 mm

HOEN Raspatory, 20.0 mm, 190 mm

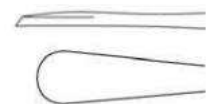
06-11-306 ADSON Raspatorium, 8,0 mm, 170 mm

ADSON Raspatory, 8.0 mm, 170 mm

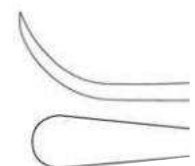
06-11-307 ADSON Raspatorium, 7,0 mm, 170 mm

ADSON Raspatory, 7.0 mm, 170 mm

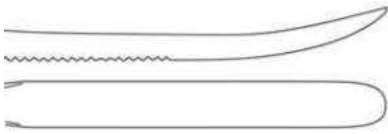
06-11-308 ADSON Raspatorium, 7,0 mm, 170 mm

ADSON Raspatory, 7.0 mm, 170 mm

06-11-309 ADSON Raspatorium, 7,0 mm, 170 mm

ADSON Raspatory, 7.0 mm, 170 mm

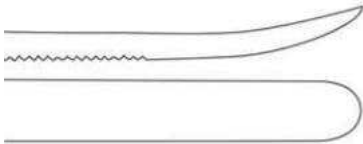

06-11-301 Raspatorium, 6,0 mm, 165 mm

Raspatory, 6.0 mm, 165 mm



06-11-302 Raspatorium, 8,0 mm, 165 mm

Raspatory, 8.0 mm, 165 mm



KEY Raspatorium

KEY Raspatory

06-61-410	3,0 mm, 180 mm		3.0 mm, 180 mm	
06-11-410	6,0 mm, 180 mm		6.0 mm, 180 mm	
06-11-411	10,0 mm, 190 mm		10.0 mm, 190 mm	
06-11-412	13,0 mm, 190 mm		13.0 mm, 190 mm	
06-61-412	16,0 mm, 190 mm		16.0 mm, 190 mm	
06-11-413	19,0 mm, 200 mm		19.0 mm, 200 mm	
06-11-414	25,0 mm, 210 mm		25.0 mm, 210 mm	



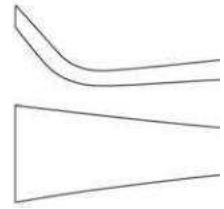

06-11-365 SCHNEIDER Raspatorium, 13,0 mm, 175 mm

SCHNEIDER Raspatory, 13.0 mm, 175 mm

06-11-366 SCHNEIDER-SAUERBRUCH Raspatorium, 14,0 mm, 190 mm

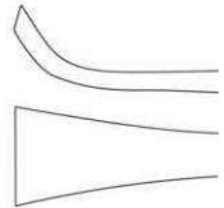
SCHNEIDER-SAUERBRUCH Raspatory, 14.0 mm, 190 mm

06-11-351 SEDILLOT Raspatorium, 15,0 mm, 215 mm

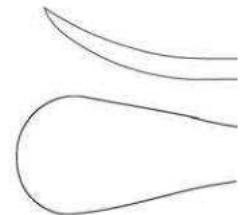
SEDILLOT Raspatory, 15.0 mm, 215 mm

06-11-310 JOSEPH Raspatorium, 4,0 mm, 180 mm

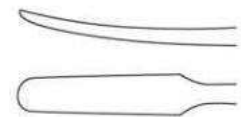
JOSEPH Raspatory, 4.0 mm, 180 mm

06-11-362 JANSEN Raspatorium, 15,0 mm, 165 mm

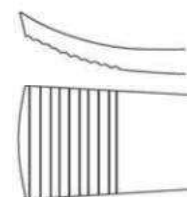
JANSEN Raspatory, 15.0 mm, 165 mm



06-11-394

MÜHLING Raspatorium, 4,0 mm, 170 mm

MÜHLING Raspatory, 4.0 mm, 170 mm



06-11-395

MÜHLING Raspatorium, 4,0 mm, 170 mm

MÜHLING Raspatory, 4.0 mm, 170 mm



06-11-396

MÜHLING Raspatorium, 4,0 mm, 170 mm

MÜHLING Raspatory, 4.0 mm, 170 mm



06-11-397

MÜHLING Raspatorium, 4,0 mm, 170 mm

MÜHLING Raspatory, 4.0 mm, 170 mm



04-15-521

Raspatorium, 3,0 mm, 170 mm

Raspatory, 3.0 mm, 170 mm



04-15-523

Raspatorium, 6,0 mm, 170 mm

Raspatory, 6.0 mm, 170 mm



06-11-314

LANDOLT Raspatorium, 4,7 mm, 175 mm

LANDOLT Raspatory, 4.7 mm, 175 mm



06-11-328

CASPAR Raspatorium, 6,2 mm, 180 mm

CASPAR Raspatory, 6.2 mm, 180 mm



06-11-329

CASPAR Raspatorium, 6,2 mm, 180 mm

CASPAR Raspatory, 6.2 mm, 180 mm



15-12-157

COTTLE Raspatorium, 8,0 mm, 195 mm

COTTLE Raspatory, 8.0 mm, 195 mm



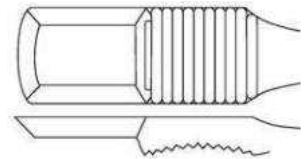

06-11-340 FARABEUF Raspatorium, gerade, 12,5 mm, 140 mm

FARABEUF Raspatory, straight, 12.5 mm, 140 mm

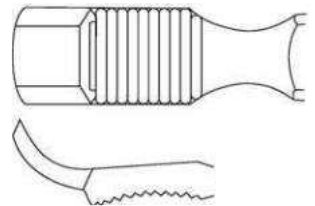

06-11-341 FARABEUF Raspatorium, gebogen, 12,5 mm, 140 mm

FARABEUF Raspatory, curved, 12.5 mm, 140 mm

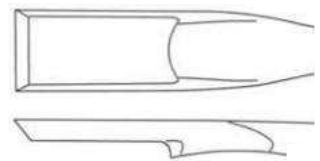

06-11-344 FARABEUF-COLLIN Raspatorium, gerade, 11,0 mm, 160 mm

FARABEUF-COLLIN Raspatory, straight, 11.0 mm, 160 mm

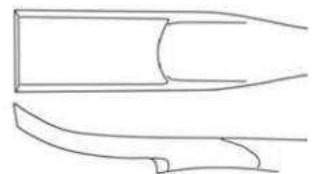

06-11-345 FARABEUF-COLLIN Raspatorium, gebogen, 11,0 mm, 160 mm

FARABEUF-COLLIN Raspatory, curved, 11.0 mm, 160 mm

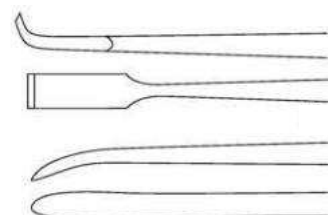

15-12-171 HOWARTH Raspatorium, scharf/stumpf, 215 mm

HOWARTH Raspatory, sharp/blunt, 215 mm

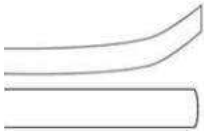

06-11-355 LAMBOTTE Raspatorium, 5,0 mm, 215 mm

LAMBOTTE Raspatory, 5.0 mm, 215 mm



06-11-356 LAMBOTTE Raspatorium, 10,0 mm, 215 mm

LAMBOTTE Raspatory, 10.0 mm, 215 mm



06-11-357 LAMBOTTE Raspatorium, 15,0 mm, 215 mm

LAMBOTTE Raspatory, 15.0 mm, 215 mm



06-11-358 LAMBOTTE Raspatorium, 20,0 mm, 215 mm

LAMBOTTE Raspatory, 20.0 mm, 215 mm

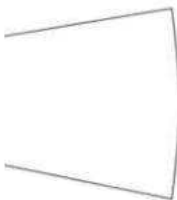

06-11-359 LAMBOTTE Raspatorium, 25,0 mm, 215 mm

LAMBOTTE Raspatory, 25.0 mm, 215 mm

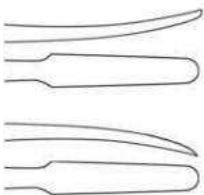

15-12-170 KILLIAN Raspatorium, scharf/stumpf, 185 mm

KILLIAN Raspatory, sharp/blunt, 185 mm

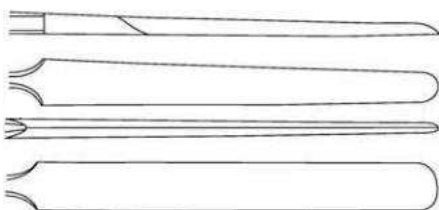

15-12-172 KILLIAN Raspatorium, scharf/stumpf, 185 mm

KILLIAN Raspatory, sharp/blunt, 185 mm



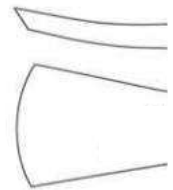

06-11-360 LANGENBECK Raspatorium, 16,0 mm, 190 mm

LANGENBECK Raspatory, 16.0 mm, 190 mm

06-11-361 LANGENBECK Raspatorium, 14,0 mm, 180 mm

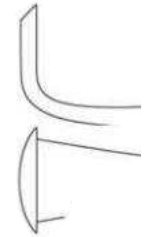
LANGENBECK Raspatory, 14.0 mm, 180 mm

06-11-379 MC KISSOCK Raspatorium, 11,0 mm, 195 mm

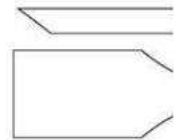
MC KISSOCK Raspatory, 11.0 mm, 195 mm

06-11-390 KRÄMER Raspatorium, 10,0 mm, 185 mm

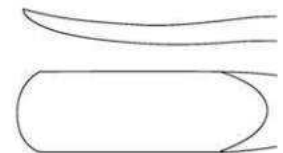
KRÄMER Raspatory, 10.0 mm, 185 mm

06-11-391 KRÄMER Raspatorium, 10,0 mm, 190 mm

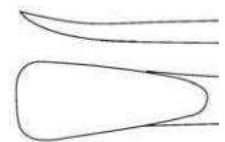
KRÄMER Raspatory, 10.0 mm, 190 mm

04-15-518 BÜCHS Raspatorium, 9,5 mm, 190 mm

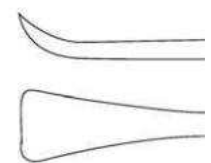
BÜCHS Raspatory, 9.5 mm, 190 mm

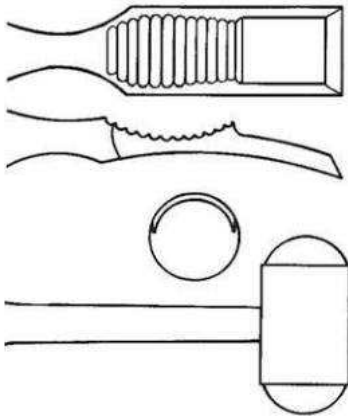

06-61-419	ALEXANDER Raspatorium, 160 mm	ALEXANDER Raspatory, 160 mm
06-11-420	ALEXANDER Raspatorium, 200 mm	ALEXANDER Raspatory, 200 mm

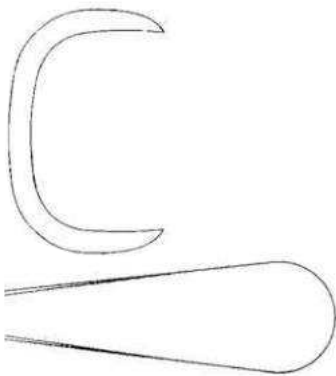

06-61-421	MATSON Raspatorium, 220 mm	MATSON Raspatory, 220 mm
-----------	----------------------------	--------------------------



06-61-420	MATSON ALEXANDER Raspatorium, 220 mm	MATSON ALEXANDER Raspatory, 220 mm
-----------	--------------------------------------	------------------------------------



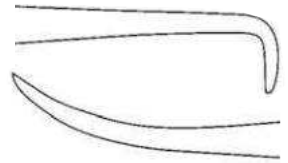

06-61-422 OVERHOLT Raspatorium, 295 mm

OVERHOLT Raspatory, 295 mm

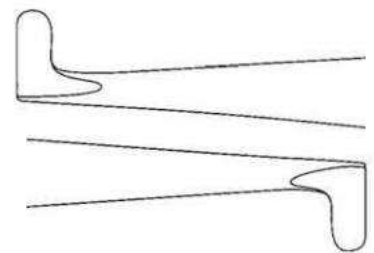
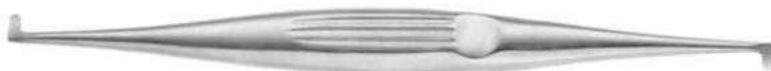

06-61-423 OVERHOLT Raspatorium, 295 mm

OVERHOLT Raspatory, 295 mm

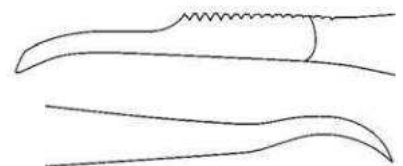

06-61-424 OVERHOLT Raspatorium, 285 mm

OVERHOLT Raspatory, 285 mm



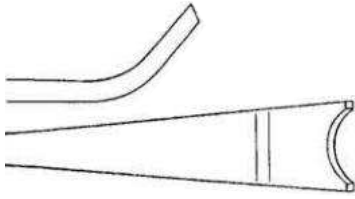

06-11-381 SEMB Raspatorium, 12,0 mm, 185 mm



SEMB Raspatory, 12.0 mm, 185 mm

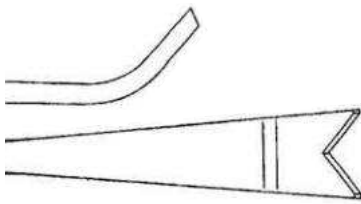

06-11-382 SEMB Raspatorium, 12,0 mm, 215 mm



SEMB Raspatory, 12.0 mm, 215 mm

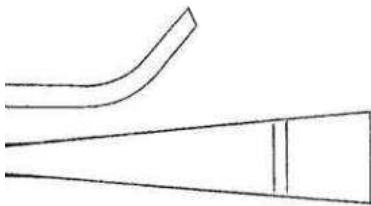

06-11-383 SEMB Raspatorium, 13,0 mm, 185 mm



SEMB Raspatory, 13.0 mm, 185 mm

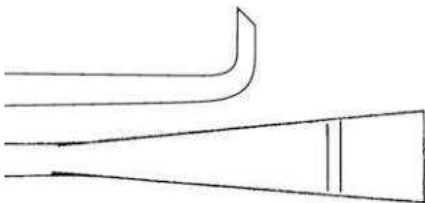

06-11-384 SEMB Raspatorium, 13,0 mm, 215 mm



SEMB Raspatory, 13.0 mm, 215 mm

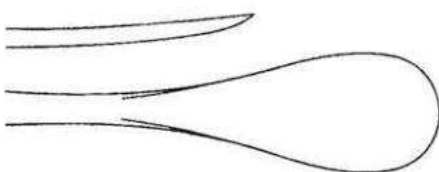

06-11-387 SEMB Raspatorium, 15,0 mm, 210 mm



SEMB Raspatory, 15.0 mm, 210 mm



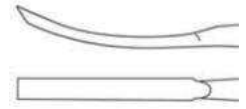

06-11-317 Raspatorium, gebogen, 3,0 mm, 185 mm

Raspatory, curved, 3.0 mm, 185 mm

06-11-318 Raspatorium, gerade, 6,0 mm, 190 mm

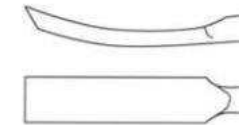
Raspatory, straight, 6.0 mm, 190 mm

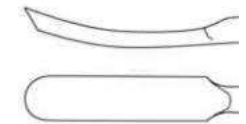
06-11-319 Raspatorium, gebogen, 6,0 mm, 190 mm

Raspatory, curved, 6.0 mm, 190 mm

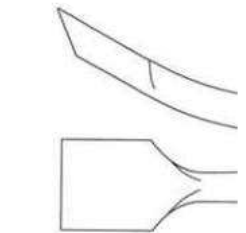
06-11-321 Raspatorium, gebogen, 6,0 mm, 190 mm

Raspatory, curved, 6.0 mm, 190 mm

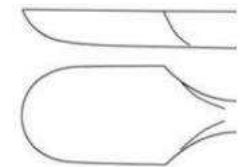
06-11-323 Raspatorium, gebogen, 13,0 mm, 185 mm

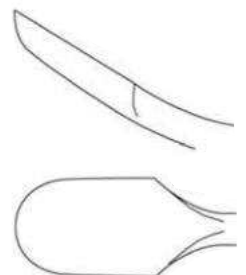
Raspatory, curved, 13.0 mm, 185 mm

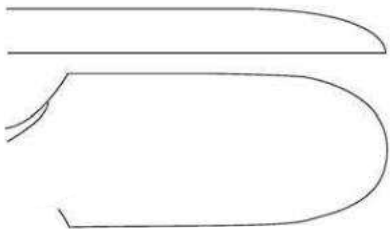
06-11-324 Raspatorium, gerade, 14,0 mm, 195 mm

Raspatory, straight, 14.0 mm, 195 mm

06-11-325 Raspatorium, gebogen, 14,0 mm, 190 mm

Raspatory, curved, 14.0 mm, 190 mm

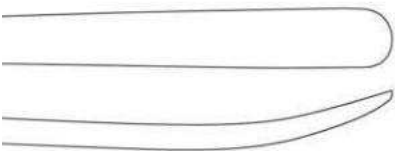

06-61-327 Raspatorium, gerade, 20,0 mm, 205 mm

Raspatory, straight, 20.0 mm, 205 mm



06-61-328 WAGNER Raspatorium, 8,0 mm, 330 mm

WAGNER Raspatory, 8.0 mm, 330 mm

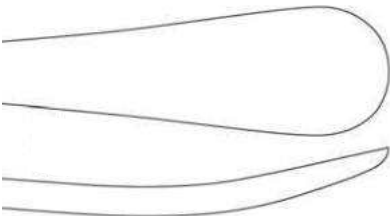

06-61-329 WAGNER Raspatorium, 17,0 mm, 330 mm

WAGNER Raspatory, 17.0 mm, 330 mm

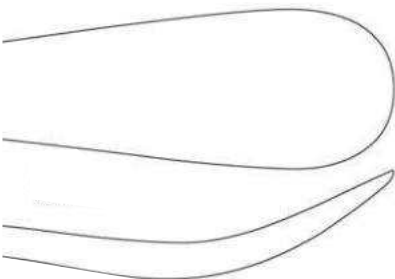

06-61-330 WAGNER Raspatorium, 21,0 mm, 275 mm

WAGNER Raspatory, 21.0 mm, 275 mm



06-11-146 COBB Raspatorium, 10,0 mm, 290 mm

COBB Raspatory, 10.0 mm, 290 mm
06-11-147 COBB Raspatorium, 13,0 mm, 290 mm

COBB Raspatory, 13.0 mm, 290 mm
06-11-148 COBB Raspatorium, 19,0 mm, 290 mm

COBB Raspatory, 19.0 mm, 290 mm
06-61-150 COBB Raspatorium, 25,0 mm, 290 mm

COBB Raspatory, 25.0 mm, 290 mm
06-61-331 COBB Raspatorium, 4,0 mm, 280 mm

COBB Raspatory, 4.0 mm, 280 mm
06-61-332 COBB Raspatorium, 6,0 mm, 280 mm

COBB Raspatory, 6.0 mm, 280 mm
06-61-333 COBB Raspatorium, 8,0 mm, 280 mm

COBB Raspatory, 8.0 mm, 280 mm

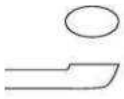
06-11-530

MANNERFELT Raspatorium, 4,0 mm, 155 mm

MANNERFELT Raspatory, 4.0 mm, 155 mm

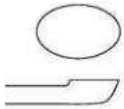

06-11-532

MANNERFELT Raspatorium, 7,0 mm, 155 mm

MANNERFELT Raspatory, 7.0 mm, 155 mm



06-11-534

MANNERFELT Raspatorium, 9,0 mm, 155 mm

MANNERFELT Raspatory, 9.0 mm, 155 mm

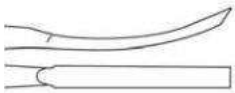

06-11-541

MANNERFELT Raspatorium, 3,0 mm, 155 mm

MANNERFELT Raspatory, 3.0 mm, 155 mm

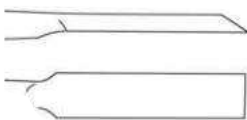

06-11-542

MANNERFELT Raspatorium, 6,0 mm, 155 mm

MANNERFELT Raspatory, 6.0 mm, 155 mm

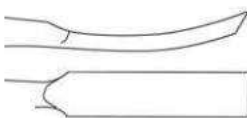

06-11-543

MANNERFELT Raspatorium, 6,0 mm, 155 mm

MANNERFELT Raspatory, 6.0 mm, 155 mm

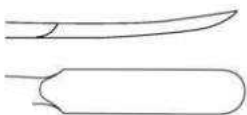

06-11-551

MANNERFELT Raspatorium, 6,0 mm, 155 mm

MANNERFELT Raspatory, 6.0 mm, 155 mm

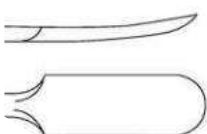

06-11-552

MANNERFELT Raspatorium, 8,0 mm, 155 mm

MANNERFELT Raspatory, 8.0 mm, 155 mm





06-11-556 MANNERFELT Raspatorium, 4,0 mm, 155 mm

MANNERFELT Raspatory, 4.0 mm, 155 mm

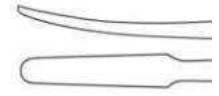

06-11-554 MANNERFELT Raspatorium, 5,0 mm, 155 mm

MANNERFELT Raspatory, 5.0 mm, 155 mm

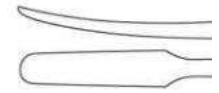

06-11-553 MANNERFELT Raspatorium, 6,0 mm, 155 mm

MANNERFELT Raspatory, 6.0 mm, 155 mm



06-11-560 MANNERFELT Raspatorium, 4,0 mm, 155 mm

MANNERFELT Raspatory, 4.0 mm, 155 mm

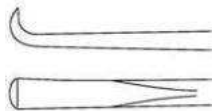

06-11-562 MANNERFELT Raspatorium, 6,0 mm, 155 mm

MANNERFELT Raspatory, 6.0 mm, 155 mm

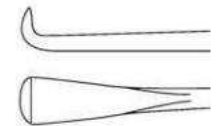

06-11-565 MANNERFELT Raspatorium, 3,5 mm, 155 mm

MANNERFELT Raspatory, 3.5 mm, 155 mm

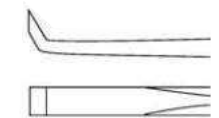

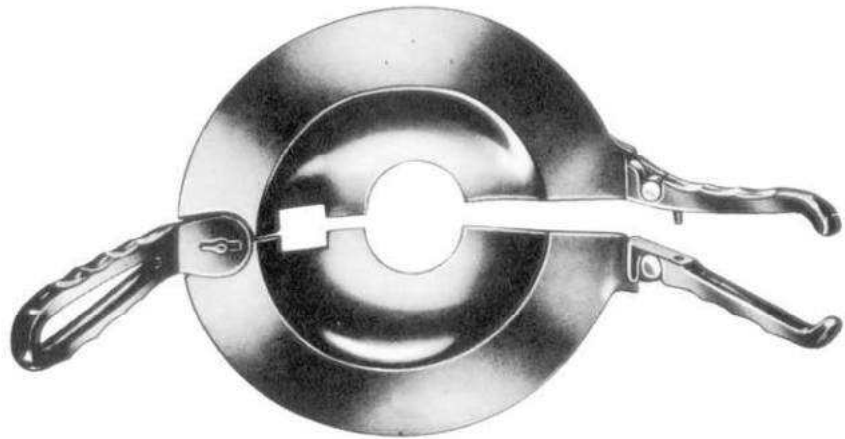

06-08-220 PERCY Amputationsretractor

PERCY Amputation retractor

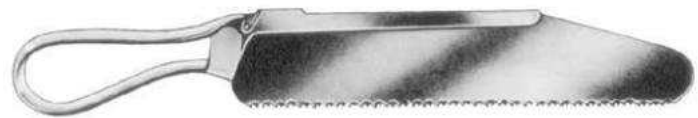

06-08-320 CHARRIÈRE Säge, 270 mm

CHARRIÈRE Saw, 270 mm

06-08-322 CHARRIÈRE Säge, 340 mm

CHARRIÈRE Saw, 340 mm

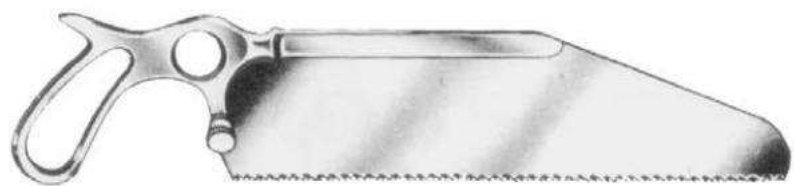

06-08-325 SATTERLEE Säge, 310 mm

SATTERLEE Saw, 310 mm

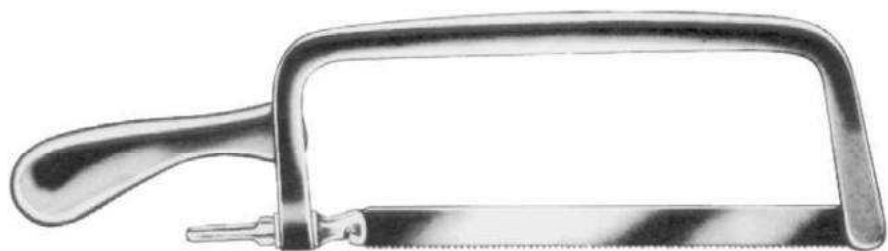

06-08-300 CHARRIÈRE Säge, 350 mm

CHARRIÈRE Saw, 350 mm



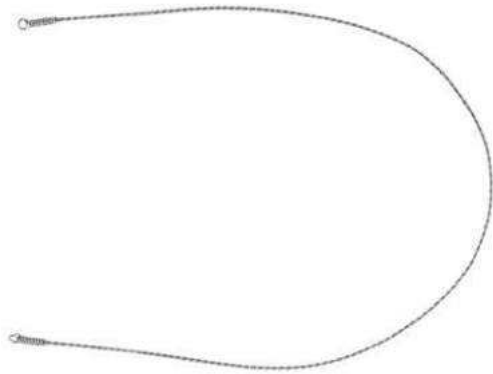

06-08-413	GIGLI Drahtsäge, 300 mm	<i>GIGLI Wire saw, 300 mm</i>
06-08-414	GIGLI Drahtsäge, 400 mm	<i>GIGLI Wire saw, 400 mm</i>
06-08-415	GIGLI Drahtsäge, 500 mm	<i>GIGLI Wire saw, 500 mm</i>

06-08-403	OLIVECRONA Drahtsäge, 300 mm	<i>OLIVECRONA Wire saw, 300 mm</i>
06-08-404	OLIVECRONA Drahtsäge, 400 mm	<i>OLIVECRONA Wire saw, 400 mm</i>
06-08-405	OLIVECRONA Drahtsäge, 500 mm	<i>OLIVECRONA Wire saw, 500 mm</i>
06-08-407	OLIVECRONA Drahtsäge, 700 mm	<i>OLIVECRONA Wire saw, 700 mm</i>



06-08-480	GIGLI Handgriffe für Drahtsägen, Packung à 2 Stück	<i>GIGLI Handles for wire saws, package with 2 pieces</i>
-----------	--	---



06-06-130	DE MARTEL Umföhrungsinstrument für Drahtsägen, flexibel, 350 mm	<i>DE MARTEL Conductor for wire saws, flexible, 350 mm</i>
-----------	---	--



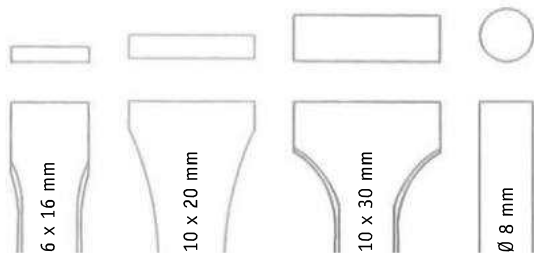

50-93-101	Einschläger, 6,0 x 16,0 mm, 250 mm	Impactor, 6.0 x 16.0 mm, 250 mm
50-93-102	Einschläger, 10,0 x 20,0 mm, 250 mm	Impactor, 10.0 x 20.0 mm, 250 mm
50-93-103	Einschläger, 10,0 x 30,0 mm, 250 mm	Impactor, 10.0 x 30.0 mm, 250 mm
50-93-104	Einschläger, Ø 8,0 mm, 250 mm	Impactor, Ø 8.0 mm, 250 mm

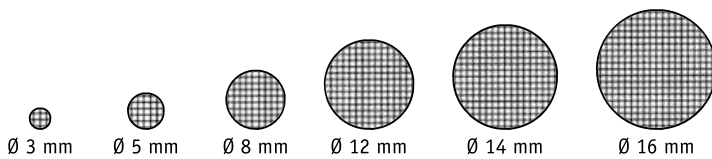

06-06-913	CASPAR Einschläger, Ø 3,0 mm, 200 mm	CASPAR Impactor, Ø 3.0 mm, 200 mm
06-06-914	CASPAR Einschläger, Ø 5,0 mm, 200 mm	CASPAR Impactor, Ø 5.0 mm, 200 mm
06-06-915	CASPAR Einschläger, Ø 8,0 mm, 200 mm	CASPAR Impactor, Ø 8.0 mm, 200 mm
06-12-090	Einschläger, Ø 12,0 mm, 200 mm	Impactor, Ø 12.0 mm, 200 mm
06-12-091	Einschläger, Ø 14,0 mm, 200 mm	Impactor, Ø 14.0 mm, 200 mm
06-12-092	Einschläger, Ø 16,0 mm, 200 mm	Impactor, Ø 16.0 mm, 200 mm

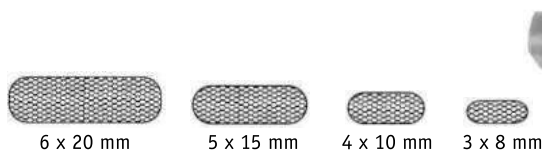

06-07-093	SYPERT Einschläger, 3,0 x 8,0 mm, 290 mm	SYPERT Impactor, 3.0 x 8.0 mm, 290 mm
06-07-094	Einschläger, 4,0 x 10,0 mm, 290 mm	Impactor, 4.0 x 10.0 mm, 290 mm
06-07-095	Einschläger, 5,0 x 15,0 mm, 290 mm	Impactor, 5.0 x 15.0 mm, 290 mm
06-07-096	Einschläger, 6,0 x 20,0 mm, 290 mm	Impactor, 6.0 x 20.0 mm, 290 mm



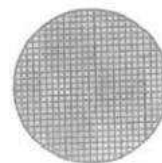
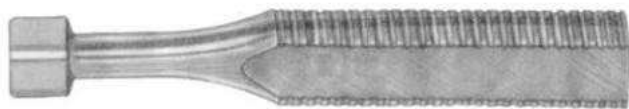

50-93-105	Einschläger, mit Nylon-Aufsatz und Aluminium Griff, 165 mm	Impactor with nylon cap and aluminium handle, 165 mm
-----------	--	--

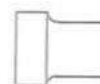

50-93-106	Einschläger, rund, Ø 10,0 mm, 430 mm	Impactor, round, Ø 10.0 mm, 430 mm
-----------	--------------------------------------	------------------------------------



50-93-107	Einschläger, rund, Ø 2,0 mm, 150 mm	Impactor, round, Ø 2.0 mm, 150 mm
50-93-108	Einschläger, rund, Ø 3,0 mm, 150 mm	Impactor, round, Ø 3.0 mm, 150 mm
50-93-109	Einschläger, rund, Ø 4,0 mm, 150 mm	Impactor, round, Ø 4.0 mm, 150 mm
50-93-110	Einschläger, rund, Ø 5,0 mm, 150 mm	Impactor, round, Ø 5.0 mm, 150 mm
50-93-111	Einschläger, rund, Ø 6,0 mm, 150 mm	Impactor, round, Ø 6.0 mm, 150 mm
50-93-112	Einschläger, rund, Ø 8,0 mm, 150 mm	Impactor, round, Ø 8.0 mm, 150 mm
50-93-113	Einschläger, rund, Ø 10,0 mm, 150 mm	Impactor, round, Ø 10.0 mm, 150 mm

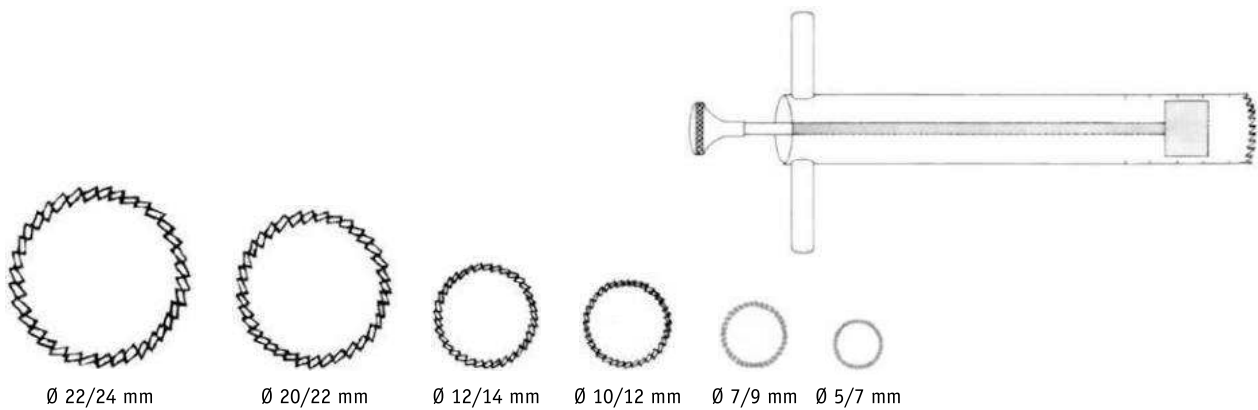

50-93-201	Knochenfräser, Ø 5/7 mm, 150 mm	Bone plug cutter, Ø 5/7 mm, 150 mm
50-93-202	Knochenfräser, Ø 7/9 mm, 150 mm	Bone plug cutter, Ø 7/9 mm, 150 mm
50-93-203	Knochenfräser, Ø 10/12 mm, 150 mm	Bone plug cutter, Ø 10/12 mm, 150 mm
50-93-204	Knochenfräser, Ø 12/14 mm, 150 mm	Bone plug cutter, Ø 12/14 mm, 150 mm
50-93-205	Knochenfräser, Ø 20/22 mm, 150 mm	Bone plug cutter, Ø 20/22 mm, 150 mm
50-93-206	Knochenfräser, Ø 22/24 mm, 150 mm	Bone plug cutter, Ø 22/24 mm, 150 mm

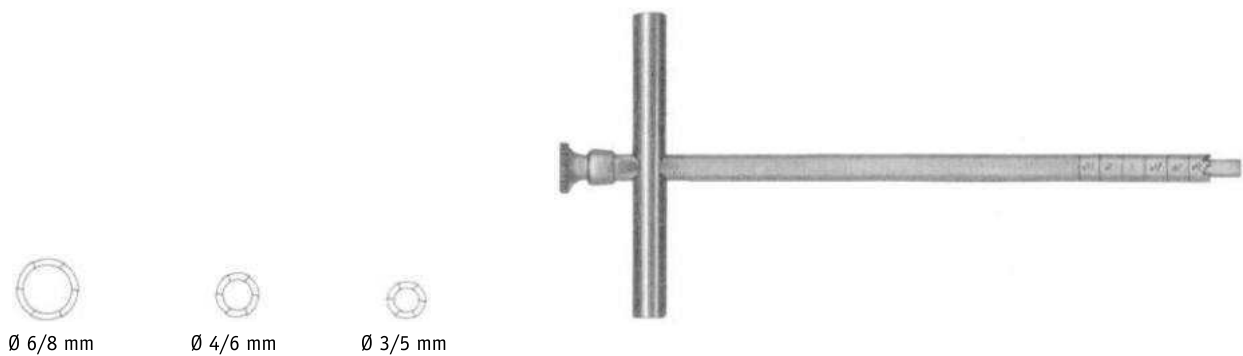

50-93-207	MICHELE Trepan, Ø 3/5 mm, 180 mm	MICHELE Trepine, Ø 3/5 mm, 180 mm
50-93-208	MICHELE Trepan, Ø 4/6 mm, 180 mm	MICHELE Trepine, Ø 4/6 mm, 180 mm
50-93-209	MICHELE Trepan, Ø 6/8 mm, 180 mm	MICHELE Trepine, Ø 6/8 mm, 180 mm



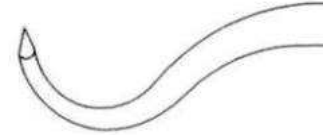

50-93-210 Schulter-Perkussion-Ahle, klein, 220 mm

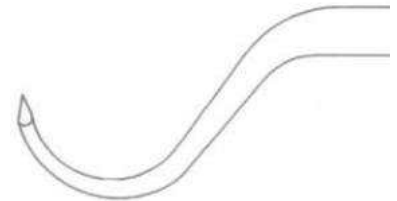
Shoulder percussion awl, small, 220 mm

50-93-211 Schulter-Perkussion-Ahle, mittel, 220 mm

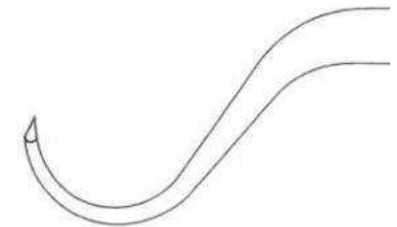
Shoulder percussion awl, medium, 220 mm

50-93-212 Schulter-Penetration-Ahle, klein, 220 mm

Shoulder penetrating awl, small, 220 mm

50-93-213 Schulter-Perkussion-Ahle, groß, 220 mm

Shoulder percussion awl, large, 220 mm